

na·De®

FİYAT LİSTESİ MAYIS 2024

SENSÖR VE SENSÖRLÜ AYDINLATMA SİSTEMLERİ

AYDINLATMA VE ACİL YÖNLENDİRME SİSTEMLERİ

GÖRÜNTÜLÜ VE SESLİ İNTERKOM SİSTEMLERİ

YANGIN ALGILAMA VE UYARI SİSTEMLERİ

DMY
ELEKTRİK | OTOMASYON | AYDINLATMA

ALGA SAVIOR na·de





"q./mınfut/He!u:A "

na·De®

"DMY Elektrik Otomasyon Aydınlatma A.Ş." (www.dmyeoa.com.tr) 2020 yılında DMY grup bünyesinde faaliyet gösteren "ALGA", "SAVIOR" ve "NA-DE" firmalarının bir araya gelmesi ile oluşan yeni bir yapılaşmadır.

Her biri kendi alanında uzun yıllardır faaliyet gösteren bu firmaların bir araya gelmesinde DMY Grup tarafından ciddi bir sinerji yaratarak ekonomik faaliyetin gelişmesi amaçlanmış ve geçen kısa sürede bunun etkisi pozitif olarak elde edilmiştir.

Birleşen üç firmanın faaliyet alanları birbirinden farklılıklar içerse bile kesişen noktalar ve kesişen hizmetlerin daha kaliteli verilmesi ana amaçlardan birisi olarak gerçekleştirildi.

DMY grubun Sancaktepe'de yer alan adresinde toplanan firmalar "DMYEEOA" adı altında toplamda 12.000 m² kapalı alanda üretim, lojistik, teknik servis ve diğer hizmetlerini vermektedir.

Firmamızın merkezi dışındaki faaliyetleri Ankara, İzmir, Bursa ve Karaköy (Showroom) şubeleri ile Adana, Gaziantep, Antalya ve Trabzon temsilcilikleri tarafından sürdürülmektedir.

Firma bünyesinde üretim faaliyeti kendi sektöründe öncü konumda yer alan "NA-DE" markası için gerçekleştirmekte ve 50 yıldan fazladır yerli ve kaliteli ürünlerini Aydınlatma, Sensör, Görüntülü ve Sesli Diafon, Yangın Algılama, Güneş enerjili aydınlatma armatürleri ve fiyat panoları sektörlerinde, Türkiye çapında bayileri aracılığı ile son kullanıcının hizmetine sunmaktadır.

"NA-DE", yakaladığı bugünkü çizgisi ile sektöründe oldukça iddialı bir yer edinmiştir. Modern altyapısı ve test cihazlarıyla her türlü donanıma sahip laboratuvarlarında AR-GE faaliyetleri yürüterek uzun vadeli çalışmaların sonucu olarak %100 Türk Malı yerli üretim ilk "Hareket Sensörü"nü ve "Hareket Sensörlü Tavan ve Duvar Tipi Aydınlatma Armatürleri"ni de yeni tasarım ürünler yelpazesine eklemiş ve müşterilerinin hizmetine sunmuştur. "NA-DE", üretimini en son teknoloji makine ve donanım ile gerçekleştirmekte, Ulusal (TSE) ve uluslararası standartlara (ISO 9001, CE, TUV GS) uygun olan ürünlerini iç ve dış piyasaya sunmaktadır.

"NA-DE", geleceğe yönelik sağlam adımlarla ilerlemekte ve gelişmektedir. İzlemiş olduğu kalite politikaları ve 2018 yılında kurulmuş olan AR-GE merkezinde yürütmekte olduğu faaliyetleri sonucu üretim tekniklerinde kaydettiği ilerlemeler ve modernizasyon girişimleriyle kendisini ve üretim portföyünü yenilemektedir.

Elektrik depolama segmentinde önceki dönemde "ALGA Mühendislik A.Ş." olarak faaliyet gösteren firmamız bünyesinde yer alan "USB" ve "CGB" markalı TSE standartlarına uygun olarak belgelenmiş endüstriyel tip kuru VRLA, GEL ve Li-Ion aküleri yine "DMYEEOA" bünyesinde satış dağıtım ve garanti faaliyetlerini sürdürmektedir. İthalat, ihracat satış dağıtım ve satış sonrası servisleri ile bu ürünlere ihtiyaç duyan değişik sektörlerin ihtiyacını yine bayilerimiz veya direk kanallar üzerinden son kullanıcıya iletmekteyiz. Ürünlerin özellikleri nedeni ile her zaman güncel ve uygun saklama koşulları ile kullanıcıya ulaşması için gerekli hassasiyeti göstermek önceliklerimiz arasındadır.

Makine Otomasyon alanında önceki dönemde "SAVIOR Kontrol Otomasyon A.Ş." olarak faaliyet gösteren firmamızda Panasonic, ABB, Weintek, INVT, Euradrive, Trio Motion, HSC, Chint gibi dünya markalarının otomasyon ve elektrik pazarına yönelik olarak servo motor, servo sürücü, frekans konverterleri, invertörler, HMI, kontrol panelleri, endüstriyel PC'ler, AG ŞALT ürünleri, otomasyon röleleri, yumuşak yolvericiler, PLC'ler, CNC kontrolcüler gibi ürün gruplarında Türkiye temsilciliğini veya dağıtıcılığını yapmaktayız.

Bu ürünler ile ilgili satış, teknik destek, teknik servis hizmetlerini güçlü ve tecrübeli kadrosu ile ifa ederek ; makine üreticileri, HVAC, denizcilik, plastik, demir çelik gibi değişik endüstriyel sektörlerle fayda ve değer yaratmaya çalışmaktayız.

DMY grup bünyesinde barındırdığı elektrik, elektronik ve güç elektroniği ile ilgili sektörlerde gösterdiği faaliyetler ile sanayi ve endüstriyel gelişmeyi sağlayacak bir çok girdi ürünleri ve katma değerli hizmetler sunmaktadır.

Bu paralelde "DMYEEOA" da üzerine düşen payda ile ilgili değişik alanlardaki faaliyetlerini büyüterek ve genişleterek sürdürmektedir.

na·de®

AYDINLATMA VE ACİL YÖNLENDİRME SİSTEMLERİ



AYDINLATMA SİSTEMLERİ

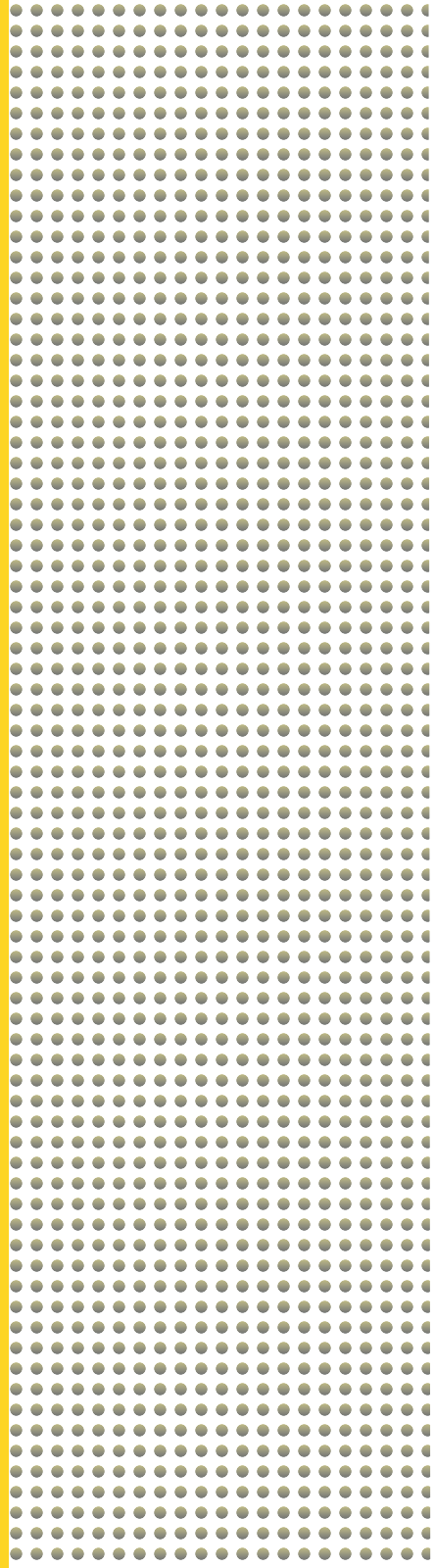

ACİL YÖNLENDİRME

EXIT ARMATÜRLERİ

ÜRÜN KODU

ÜRÜN ADI

KOLİ AD.

FİYAT



15036-48

48 Ledli Sıva Üstü Acil Aydınlatma Armatürü

24

52,00 \$



15136-48

48 Ledli Sıva Üstü Sürekli Acil/Aydınlatma Armatürü

24

63,00 \$



15036-48-N**

48 Ledli Sıva Üstü Acil Aydınlatma Armatürü

24

55,00 \$

15036-48-ÖZEL

48 Ledli Sıva Üstü Acil Aydınlatma Armatürü

24

57,00 \$

** Ürün Kodu İle Birlikte Yön Bilgisini
Aşağıdaki Etiketlerden Seçiniz.



15136-48-N**

48 Ledli Sıva Üstü Sürekli Acil/Aydınlatma Armatürü

24

65,00 \$

15136-48-ÖZEL

48 Ledli Sıva Üstü Sürekli Acil/Aydınlatma Armatürü

24

67,00 \$

** Ürün Kodu İle Birlikte Yön Bilgisini
Aşağıdaki Etiketlerden Seçiniz.

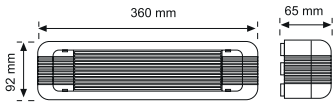

16036/16136 Serisi

*** Acil Yönlendirme Etiket Alternatifleri

N1 EXIT

N3

N9

N11

N13

N15 EXIT ÇIKIŞ

N2 ÇIKIŞ

N4

N10

N12

N14

ÖZEL
ETİKET
N-ÖZEL

ACIL YÖNLENDİRME

EXIT ARMATÜRLERİ

ÜRÜN KODU

ÜRÜN ADI

KOLİ AD.

FİYAT



16036-48

48 Ledli Sıva Altı Acil Aydınlatma Armatürü

24

48,00 \$



16136-48

48 Ledli Sıva Altı Sürekli Acil/Aydınlatma Armatürü

24

59,00 \$

16036-48-N**

48 Ledli Sıva Altı Acil Aydınlatma Armatürü

24

51,00 \$

16036-48-ÖZEL

48 Ledli Sıva Altı Acil Aydınlatma Armatürü

24

53,00 \$

** Ürün Kodu İle Birlikte Yön Bilgisini
Aşağıdaki Etiketlerden Seçiniz.

16136-48-N**

48 Ledli Sıva Altı Sürekli Acil/Aydınlatma Armatürü

24

61,00 \$

16136-48-ÖZEL

48 Ledli Sıva Altı Sürekli Acil/Aydınlatma Armatürü

24

63,00 \$

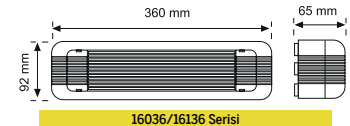
** Ürün Kodu İle Birlikte Yön Bilgisini
Aşağıdaki Etiketlerden Seçiniz.

16036/16136 Serisi

***Acil Yönlendirme Etiket Alternatifleri



ACİL YÖNLENDİRME

EXIT ARMATÜRLERİ



(Çift Taraflı)

ÜRÜN KODU	ÜRÜN ADI	KOLİ AD.	FİYAT
17110 265MM-N*	Ledli Acil Yönlendirme Zincirle Montaj	56	36,00 \$
17110 265MM-ÖZEL	Ledli Acil Yönlendirme Zincirle Montaj	56	FİYAT SORUNUZ
17110 265MM-N*-S	Ledli Acil Yönlendirme Zincirle Montaj Serigrafı	56	46,00 \$
17110 265MM-ÖZEL-S	Ledli Acil Yönlendirme Zincirle Montaj, Serigrafı	56	46,00 \$
17110 305MM-N*	Ledli Acil Yönlendirme Zincirle Montaj	56	40,00 \$
17110 305MM-ÖZEL	Ledli Acil Yönlendirme Zincirle Montaj	56	FİYAT SORUNUZ
17110 305MM-N*-S	Ledli Acil Yönlendirme Zincirle Montaj Serigrafı	56	50,00 \$
17110 305MM-ÖZEL-S	Ledli Acil Yönlendirme Zincirle Montaj Serigrafı	56	50,00 \$

*** Ürün Kodu ile Birlikte Yön Bilgisini Aşağıdaki Etiketlerden Seçiniz.



(Çift Taraflı)

17110 265MM-N*-G	Ledli Acil Yönlendirme Zincirle Montaj Gravürlü	56	48,00 \$
17110 265MM-ÖZEL-G	Ledli Acil Yönlendirme Zincirle Montaj Gravürlü	56	48,00 \$
17110 305MM-N*-G	Ledli Acil Yönlendirme Zincirle Montaj Gravürlü	56	52,00 \$
17110 305MM-ÖZEL-G	Ledli Acil Yönlendirme Zincirle Montaj Gravürlü	56	52,00 \$

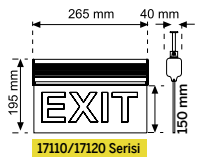

17110/17120 Serisi

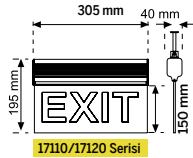

17110/17120 Serisi

*** Acil Yönlendirme Etiket Alternatifleri

N1	EXIT	N3	→	N9	→	N11	↑	N13	↑	N15	EXIT ÇIKIŞ
N2	ÇIKIŞ	N4	←	N10	←	N12	↓	N14	↓		ÖZEL ETİKET N-ÖZEL

ACIL YÖNLENDİRME

EXIT ARMATÜRLERİ



(Çift Taraflı)

ÜRÜN KODU	ÜRÜN ADI	KOLİ AD.	FİYAT
17120 265MM-N*	Ledli Acil Yönlendirme Montaj Aparatlı	56	38,00 \$
17120 265MM-ÖZEL	Ledli Acil Yönlendirme Montaj Aparatlı	28	FİYAT SORUNUZ
17120 265MM-N*-S	Ledli Acil Yönlendirme Montaj Aparatlı Serigrafı	28	48,00 \$
17120 265MM-ÖZEL-S	Ledli Acil Yönlendirme Montaj Aparatlı Serigrafı	56	48,00 \$
17120 305MM-N*	Ledli Acil Yönlendirme Montaj Aparatlı	28	42,00 \$
17120 305MM-ÖZEL	Ledli Acil Yönlendirme Montaj Aparatlı	28	FİYAT SORUNUZ
17120 305MM-N*-S	Ledli Acil Yönlendirme Montaj Aparatlı Serigrafı	28	52,00 \$
17120 305MM-ÖZEL-S	Ledli Acil Yönlendirme Montaj Aparatlı Serigrafı	28	52,00 \$

*** Ürün Kodu ile Birlikte Yön Bilgisini Aşağıdaki Etiketlerden Seçiniz.



(Çift Taraflı)

17120 265MM-N*-G	Ledli Acil Yönlendirme Montaj Aparatlı Gravürlü	28	50,00 \$
17120 265MM-ÖZEL-G	Ledli Acil Yönlendirme Montaj Aparatlı Gravürlü	28	50,00 \$
17120 305MM-N*-G	Ledli Acil Yönlendirme Montaj Aparatlı Gravürlü	28	54,00 \$
17120 305MM-ÖZEL-G	Ledli Acil Yönlendirme Montaj Aparatlı Gravürlü	28	54,00 \$

***Acil Yönlendirme Etiket Alternatifleri

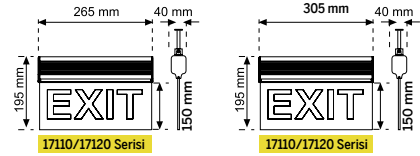

N16		N18		N18		N20		N22		N24	
N17		N19		N19		N21		N23		N25	

ACİL YÖNLENDİRME

EXIT ARMATÜRLERİ



(Çift Taraflı)

ÜRÜN KODU	ÜRÜN ADI	KOLİ AD.	FİYAT
17130 265MM-N*	Ledli Acil Yönlendirme Zincirle Montaj Alüminyum	56	40,00 \$
17130 265MM-ÖZEL	Ledli Acil Yönlendirme Zincirle Montaj Alüminyum	56	FİYAT SORUNUZ
17130 265MM-N*-S	Ledli Acil Yönlendirme Zincirle Montaj Alüminyum Serigraflı	56	50,00 \$
17130 265MM-ÖZEL-S	Ledli Acil Yönlendirme Zincirle Montaj Alüminyum Serigraflı	56	50,00 \$
17130 305MM-N*	Ledli Acil Yönlendirme Zincirle Montaj Alüminyum	56	44,00 \$
17130 305MM-ÖZEL	Ledli Acil Yönlendirme Zincirle Montaj Alüminyum	56	FİYAT SORUNUZ
17130 305MM-N*-S	Ledli Acil Yönlendirme Zincirle Montaj Alüminyum Serigraflı	56	54,00 \$
17130 305MM-ÖZEL-S	Ledli Acil Yönlendirme Zincirle Montaj Alüminyum Serigraflı	56	54,00 \$

*** Ürün Kodu İle Birlikte Yön Bilgisini Aşağıdaki Etiketlerden Seçiniz.



(Çift Taraflı)

17130 265MM-N*-G	Ledli Acil Yönlendirme Zincirle Montaj Alüminyum Gravürlü	56	52,00 \$
17130 265MM-ÖZEL-G	Ledli Acil Yönlendirme Zincirle Montaj Alüminyum Gravürlü	56	52,00 \$
17130 305MM-N*-G	Ledli Acil Yönlendirme Zincirle Montaj Alüminyum Gravürlü	56	56,00 \$
17130 305MM-ÖZEL-G	Ledli Acil Yönlendirme Zincirle Montaj Alüminyum Gravürlü	56	56,00 \$

*** Ürün Kodu İle Birlikte Yön Bilgisini Aşağıdaki Etiketlerden Seçiniz.

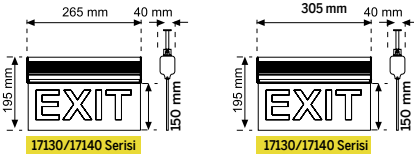

*** Acil Yönlendirme Etiket Alternatifleri

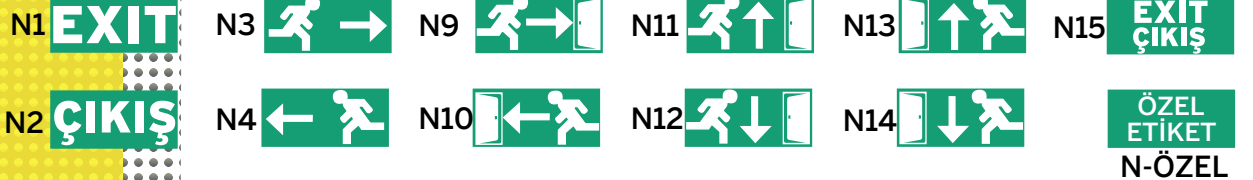

ACIL YÖNLENDİRME

EXIT ARMATÜRLERİ



ÜRÜN KODU	ÜRÜN ADI	KOLİ AD.	FİYAT
17140 265MM-N*	Ledli Acil Yönlendirme Montaj Aparatlı Alüminyum	28	42,00 \$
17140 265MM-ÖZEL	Ledli Acil Yönlendirme Montaj Aparatlı Alüminyum	28	FİYAT SORUNUZ
17140 265MM-N*-S	Ledli Acil Yönlendirme Montaj Aparatlı Alüminyum Serigraflı	28	52,00 \$
17140 265MM-ÖZEL-S	Ledli Acil Yönlendirme Montaj Aparatlı Alüminyum Serigraflı	28	52,00 \$
17140 305MM-N*	Ledli Acil Yönlendirme Montaj Aparatlı Alüminyum	28	46,00 \$
17140 305MM-N*-ÖZEL	Ledli Acil Yönlendirme Montaj Aparatlı Alüminyum	28	FİYAT SORUNUZ
17140 305MM-N*-S	Ledli Acil Yönlendirme Montaj Aparatlı Alüminyum Serigraflı	28	56,00 \$
17140 305MM-ÖZEL-S	Ledli Acil Yönlendirme Montaj Aparatlı Alüminyum Serigraflı	28	56,00 \$

*** Ürün Kodu İle Birlikte Yön Bilgisini Aşağıdaki Etiketlerden Seçiniz.

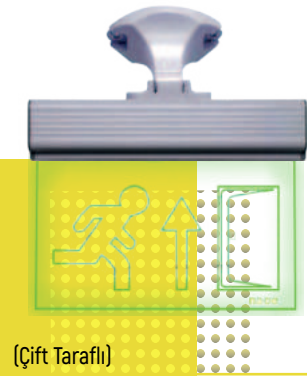

17140 265MM-N*-G	Ledli Acil Yönlendirme Montaj Aparatlı Alüminyum Gravürlü	28	54,00 \$
17140 265MM-ÖZEL-G	Ledli Acil Yönlendirme Montaj Aparatlı Alüminyum Gravürlü	28	54,00 \$
17140 305MM-N*-G	Ledli Acil Yönlendirme Montaj Aparatlı Alüminyum Gravürlü	28	58,00 \$
17140 305MM-ÖZEL-G	Ledli Acil Yönlendirme Montaj Aparatlı Alüminyum Gravürlü	28	58,00 \$

***Acil Yönlendirme Etiket Alternatifleri

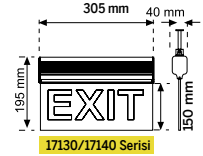
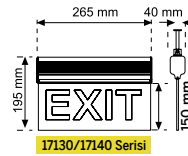

N16		N18		N18		N20		N22		N24	
N17		N19		N19		N21		N23		N25	

ACİL YÖNLENDİRME

EXIT ARMATÜRLERİ

ÜRÜN KODU	ÜRÜN ADI	KOLİ AD.	FİYAT
18110 265MM-N*	Ledli Slim Acil Yönlendirme Zincirle Montaj	56	26,00 \$
18110 265MM-ÖZEL	Ledli Slim Acil Yönlendirme Zincirle Montaj	56	FİYAT SORUNUZ
18110 265MM-N*-S	Ledli Slim Acil Yönlendirme Zincirle Montaj Serigrafılı	56	36,00 \$
18110 265MM-ÖZEL-S	Ledli Slim Acil Yönlendirme Zincirle Montaj Serigrafılı	56	36,00 \$
18110 305MM-N*	Ledli Slim Acil Yönlendirme Zincirle Montaj	56	34,00 \$
18110 305MM-ÖZEL	Ledli Slim Acil Yönlendirme Zincirle Montaj	56	FİYAT SORUNUZ
18110 305MM-N*-S	Ledli Slim Acil Yönlendirme Zincirle Montaj Serigrafılı	56	44,00 \$
18110 305MM-ÖZEL-S	Ledli Slim Acil Yönlendirme Zincirle Montaj Serigrafılı	56	44,00 \$



*** Ürün Kodu İle Birlikte Yön Bilgisini Etiketlerden Seçiniz.

18110 265MM-N*-G	Ledli Slim Acil Yönlendirme Zincirle Montaj Gravürlü	56	45,00 \$
18110 265MM-ÖZEL-G	Ledli Slim Acil Yönlendirme Zincirle Montaj Gravürlü	56	45,00 \$
18110 305MM-N*-G	Ledli Slim Acil Yönlendirme Zincirle Montaj Gravürlü	56	46,00 \$
18110 305MM-ÖZEL-G	Ledli Slim Acil Yönlendirme Zincirle Montaj Gravürlü	56	46,00 \$

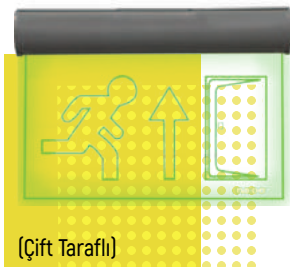

*** Ürün Kodu İle Birlikte Yön Bilgisini Etiketlerden Seçiniz.

YENİ

18110 265MM-N*-B	Ledli Slim Acil Yönlendirme Zincirle Montaj Alüminyum Butonlu	56	28,00 \$
18110 265MM-ÖZEL-B	Ledli Slim Acil Yönlendirme Zincirle Montaj Alüminyum Butonlu	56	FİYAT SORUNUZ



*** Ürün Kodu İle Birlikte Yön Bilgisini Etiketlerden Seçiniz.

ACIL YÖNLENDİRME

EXIT ARMATÜRLERİ



ÜRÜN KODU	ÜRÜN ADI	KOLİ AD.	FİYAT
18120 265MM-N*	Ledli Slim Acil Yönlendirme Montaj Aparatlı	28	26,00 \$
18120 265MM-ÖZEL	Ledli Slim Acil Yönlendirme Montaj Aparatlı	28	FİYAT SORUNUZ
18120 265MM-N*-S	Ledli Slim Acil Yönlendirme Montaj Aparatlı Serigraflı	28	36,00 \$
18120 265MM-ÖZEL-S	Ledli Slim Acil Yönlendirme Montaj Aparatlı Serigraflı	28	36,00 \$
18120 305MM-N*	Ledli Slim Acil Yönlendirme Montaj Aparatlı	28	34,00 \$
18120 305MM-ÖZEL	Ledli Slim Acil Yönlendirme Montaj Aparatlı	28	FİYAT SORUNUZ
18120 305MM-N*-S	Ledli Slim Acil Yönlendirme Montaj Aparatlı Serigraflı	28	44,00 \$
18120 305MM-ÖZEL-S	Ledli Slim Acil Yönlendirme Montaj Aparatlı Serigraflı	28	44,00 \$

*** Ürün Kodu İle Birlikte Yön Bilgisini Aşağıdaki Etiketlerden Seçiniz.

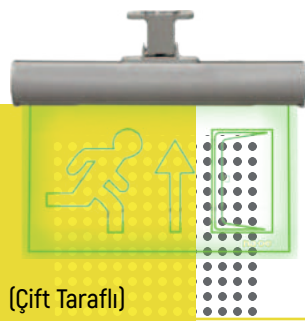

18120 265MM-N*-G	Ledli Slim Acil Yönlendirme Montaj Aparatlı Gravürlü	28	45,00 \$
18120 265MM-ÖZEL-G	Ledli Slim Acil Yönlendirme Montaj Aparatlı Gravürlü	28	45,00 \$
18120 305MM-N*-G	Ledli Slim Acil Yönlendirme Montaj Aparatlı Gravürlü	28	46,00 \$
18120 305MM-ÖZEL-G	Ledli Slim Acil Yönlendirme Montaj Aparatlı Gravürlü	28	46,00 \$

*** Ürün Kodu İle Birlikte Yön Bilgisini Aşağıdaki Etiketlerden Seçiniz.

YENİ



18120 265MM-N*-B	Ledli Slim Acil Yönlendirme Zincirle Montaj Alüminyum Butonlu	28	28,00 \$
18120 265MM-ÖZEL-B	Ledli Slim Acil Yönlendirme Zincirle Montaj Alüminyum Butonlu	28	FİYAT SORUNUZ

*** Ürün Kodu İle Birlikte Yön Bilgisini Etiketlerden Seçiniz.

ACİL YÖNLENDİRME

EXIT ARMATÜRLERİ



ÜRÜN KODU	ÜRÜN ADI	KOLİ AD.	FİYAT
18130 265MM-N*	Ledli Slim Acil Yönlendirme Zincirle Montaj Alüminyum	56	30,00 \$
18130 265MM-ÖZEL	Ledli Slim Acil Yönlendirme Zincirle Montaj Alüminyum	56	FİYAT SORUNUZ
18130 265MM-N*-S	Ledli Slim Acil Yönlendirme Zincirle Montaj Alüminyum Serigraflı	56	40,00 \$
18130 265MM-ÖZEL-S	Ledli Slim Acil Yönlendirme Zincirle Montaj Alüminyum Serigraflı	56	40,00 \$
18130 305MM-N*	Ledli Slim Acil Yönlendirme Zincirle Montaj Alüminyum	56	38,00 \$
18130 305MM-ÖZEL	Ledli Slim Acil Yönlendirme Zincirle Montaj Alüminyum	56	FİYAT SORUNUZ
18130 305MM-N*-S	Ledli Slim Acil Yönlendirme Zincirle Montaj Alüminyum Serigraflı	56	48,00 \$
18130 305MM-ÖZEL-S	Ledli Slim Acil Yönlendirme Zincirle Montaj Alüminyum Serigraflı	56	48,00 \$

*** Ürün Kodu ile Birlikte Yön Bilgisini Aşağıdaki Etiketlerden Seçiniz.

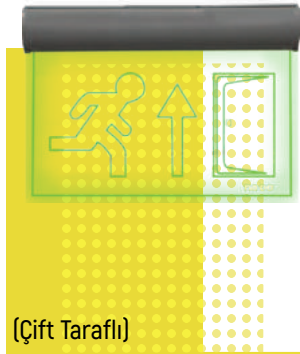

18130 265MM-N*-G	Ledli Slim Acil Yönlendirme Zincirle Montaj Alüminyum Gravürlü	56	49,00 \$
18130 265MM-ÖZEL-G	Ledli Slim Acil Yönlendirme Zincirle Montaj Alüminyum Gravürlü	56	49,00 \$
18130 305MM-N*-G	Ledli Slim Acil Yönlendirme Zincirle Montaj Alüminyum Gravürlü	56	50,00 \$
18130 305MM-ÖZEL-G	Ledli Slim Acil Yönlendirme Zincirle Montaj Alüminyum Gravürlü	56	50,00 \$

*** Ürün Kodu ile Birlikte Yön Bilgisini Aşağıdaki Etiketlerden Seçiniz.

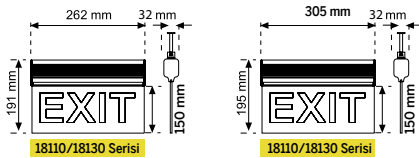

*** Acil Yönlendirme Etiket Alternatifleri

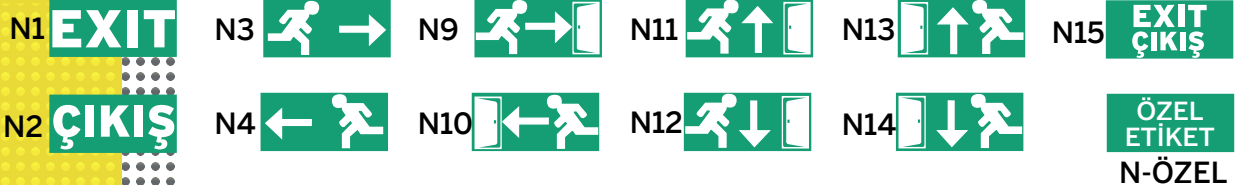

ACIL YÖNLENDİRME

na·De®

AYDINLATMA ve ACIL
YÖNLENDİRME SİSTEMLERİ

EXIT ARMATÜRLERİ



ÜRÜN KODU	ÜRÜN ADI	KOLİ AD.	FİYAT
18140 265MM-N*	Ledli Slim Acil Yönlendirme Montaj Aparatlı Alüminyum	28	30,00 \$
18140 265MM-ÖZEL	Ledli Slim Acil Yönlendirme Montaj Aparatlı Alüminyum	28	FİYAT SORUNUZ
18140 265MM-N*-S	Ledli Slim Acil Yönlendirme Montaj Aparatlı Alüminyum Serigraflı	28	40,00 \$
18140 265MM-ÖZEL-S	Ledli Slim Acil Yönlendirme Montaj Aparatlı Alüminyum Serigraflı	28	40,00 \$
18140 305MM-N*	Ledli Slim Acil Yönlendirme Montaj Aparatlı Alüminyum	28	38,00 \$
18140 305MM-ÖZEL	Ledli Slim Acil Yönlendirme Montaj Aparatlı Alüminyum	28	FİYAT SORUNUZ
18140 305MM-N*-S	Ledli Slim Acil Yönlendirme Montaj Aparatlı Alüminyum Serigraflı	28	48,00 \$
18140 305MM-ÖZEL-S	Ledli Slim Acil Yönlendirme Montaj Aparatlı Alüminyum Serigraflı	28	48,00 \$

*** Ürün Kodu İle Birlikte Yön Bilgisini Aşağıdaki Etiketlerden Seçiniz.



18140 265MM-N*-G	Ledli Slim Acil Yönlendirme Montaj Aparatlı Alüminyum Gravürlü	28	49,00 \$
18140 265MM-ÖZEL-G	Ledli Slim Acil Yönlendirme Montaj Aparatlı Alüminyum Gravürlü	28	49,00 \$
18140 305MM-N*-G	Ledli Slim Acil Yönlendirme Montaj Aparatlı Alüminyum Gravürlü	28	50,00 \$
18140 305MM-ÖZEL-G	Ledli Slim Acil Yönlendirme Montaj Aparatlı Alüminyum Gravürlü	28	50,00 \$

*** Ürün Kodu İle Birlikte Yön Bilgisini Aşağıdaki Etiketlerden Seçiniz.

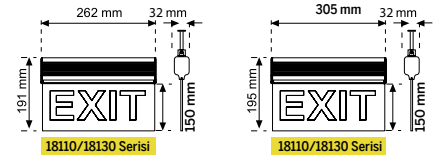

*** Acil Yönlendirme Etiket Alternatifleri



DMY Elektrik Otomasyon Aydınlatma San. ve Tic. A.Ş.
www.dmyea.com.tr



13

ACİL YÖNLENDİRME

EXIT ARMATÜRLERİ

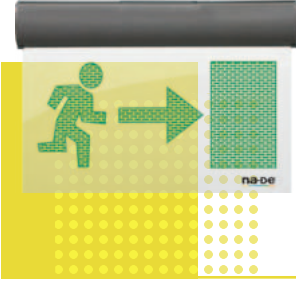

ÜRÜN ADI	KOLİ AD.	FİYAT
19110 265MM-N*	Ledli Slim Serigraflı Acil Yönlendirme Zincirle Montaj	56 34,00 \$
19110 265MM-ÖZEL	Ledli Slim Serigraflı Acil Yönlendirme Zincirle Montaj	56 34,00 \$
19110 305MM-N*	Ledli Slim Serigraflı Acil Yönlendirme Zincirle Montaj	56 43,00 \$
19110 305MM-ÖZEL	Ledli Slim Serigraflı Acil Yönlendirme Zincirle Montaj	56 43,00 \$



19120 265MM-N*	Ledli Slim Serigraflı Acil Yönlendirme Montaj Aparatlı	28 34,00 \$
19120 265MM-ÖZEL	Ledli Slim Serigraflı Acil Yönlendirme Montaj Aparatlı	28 34,00 \$
19120 305MM-N*	Ledli Slim Serigraflı Acil Yönlendirme Montaj Aparatlı	28 43,00 \$
19120 305MM-ÖZEL	Ledli Slim Serigraflı Acil Yönlendirme Montaj Aparatlı	28 43,00 \$

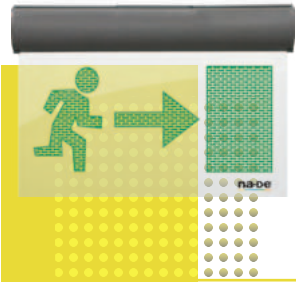

19130 265MM-N*	Ledli Slim Serigraflı Acil Yönlendirme Zincirle Montaj Alüminyum	56 38,00 \$
19130 265MM-ÖZEL	Ledli Slim Serigraflı Acil Yönlendirme Zincirle Montaj Alüminyum	56 38,00 \$
19130 305MM-N*	Ledli Slim Serigraflı Acil Yönlendirme Zincirle Montaj Alüminyum	56 47,00 \$
19130 305MM-ÖZEL	Ledli Slim Serigraflı Acil Yönlendirme Zincirle Montaj Alüminyum	56 47,00 \$



19140 265MM-N*	Ledli Slim Serigraflı Acil Yönlendirme Montaj Aparatlı Alüminyum	28 38,00 \$
19140 265MM-ÖZEL	Ledli Slim Serigraflı Acil Yönlendirme Montaj Aparatlı Alüminyum	28 38,00 \$
19140 305MM-N*	Ledli Slim Serigraflı Acil Yönlendirme Montaj Aparatlı Alüminyum	28 47,00 \$
19140 305MM-ÖZEL	Ledli Slim Serigraflı Acil Yönlendirme Montaj Aparatlı Alüminyum	28 47,00 \$

EXIT ARMATÜRLERİ

ÜRÜN KODU

ÜRÜN ADI

KOLİ AD.

FİYAT



21000

Sıva Üstü Acil Aydınlatma Armatürü 6500K

16

54,00 \$

21100

Sıva Altı Acil Aydınlatma Armatürü 6500K

16

47,00 \$

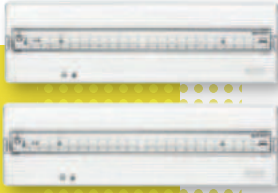

ND20024

Ledli Acil Aydınlatma Armatürü

24

30,00 \$

ND20124

Ledli Sürekli/Acil Aydınlatma Armatürü

24

30,00 \$



ND20024-N**

Ledli Acil Aydınlatma Armatürü

24

33,00 \$

ND20024-ÖZEL

Ledli Acil Aydınlatma Armatürü

24

35,00 \$

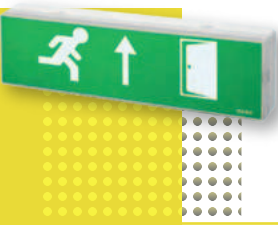

ND20124-N**

Ledli Sürekli/Acil Aydınlatma Armatürü

24

34,00 \$

ND20124-ÖZEL

Ledli Sürekli/Acil Aydınlatma Armatürü

24

36,00 \$

ACİL YÖNLENDİRME

EXIT ARMATÜRLERİ

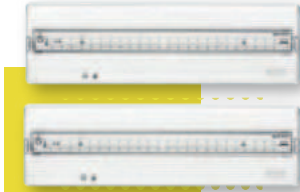

ÜRÜN KODU

ÜRÜN ADI

KOLİ AD.

FİYAT

20024-48

Ledli Acil Aydınlatma Armatürü

24

46,00 \$

20124-48

Ledli Sürekli/Acil Aydınlatma Armatürü

24

54,00 \$



20024-48-N**

Ledli Acil Aydınlatma Armatürü

24

49,00 \$

20024-48-ÖZEL

Ledli Acil Aydınlatma Armatürü

24

51,00 \$



20124-48-N**

Ledli Sürekli/Acil Aydınlatma Armatürü

24

57,00 \$

20124-48-ÖZEL

Ledli Sürekli/Acil Aydınlatma Armatürü

24

59,00 \$

Acil Yönlendirme

EXIT ARMATÜRLERİ

ÜRÜN KODU

ÜRÜN ADI

KOLİ AD.

FİYAT



17000

Ledli Acil Yönlendirme Armatürü Sıva
Altı Aparatı

65

7,00 \$

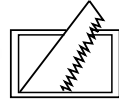

346X40 mm



17001

17110 265mm Metal Sıva Altı Aparatı

50

11,00 \$

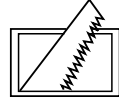

310X40 mm



17002

17110 305mm Metal Sıva Altı Aparatı

50

12,00 \$

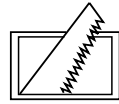

346X40 mm

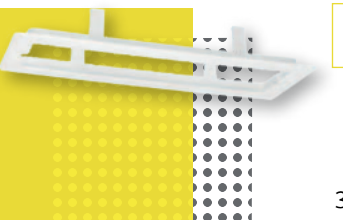

19141

Acil Yönlendirme Armatürü Sıva Altı Aparatı

1

6,00 \$

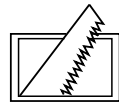

335X105 mm

BACKLIGHT ARMATÜRLER

ASTERION

ÜRÜN KODU

ÜRÜN ADI

KOLİ AD.

FİYAT

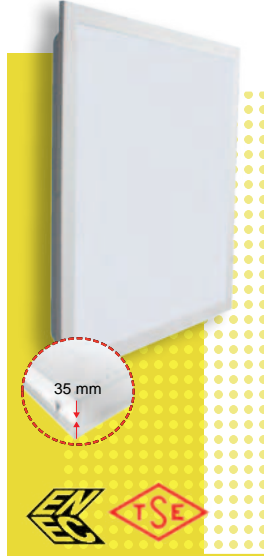

T3030183000-CL	30X30 Backlight Armatur 18W 3000K	10	21,10 \$
M3030183000-07	30X30 Backlight Armatur 18W 3000K A.K	10	61,10 \$
T3030184000-CL	30X30 Backlight Armatur 18W 4000K	10	21,10 \$
M3030184000-07	30X30 Backlight Armatur 18W 4000K A.K	10	61,10 \$
T3030186500-CL	30X30 Backlight Armatur 18W 6500K	10	21,10 \$
M3030186500-07	30X30 Backlight Armatur 18W 6500K A.K	10	61,10 \$

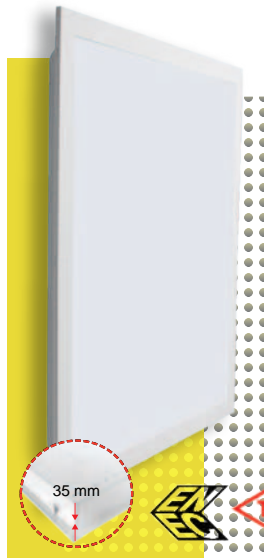

T6060363000-CL	60X60 Backlight Armatur 36W 3000K	10	34,80 \$
M6060363000-07	60X60 Backlight Armatur 36W 3000K A.K	10	74,80 \$
T6060364000-CL	60X60 Backlight Armatur 36W 4000K	10	34,80 \$
M6060364000-07	60X60 Backlight Armatur 36W 4000K A.K	10	74,80 \$
T6060366500-CL	60X60 Backlight Armatur 36W 6500K	10	34,80 \$
M6060366500-07	60X60 Backlight Armatur 36W 6500K A.K	10	74,80 \$

BACKLIGHT ARMATÜRLER

ASTERION

ÜRÜN KODU

ÜRÜN ADI

KOLİ AD.

FİYAT

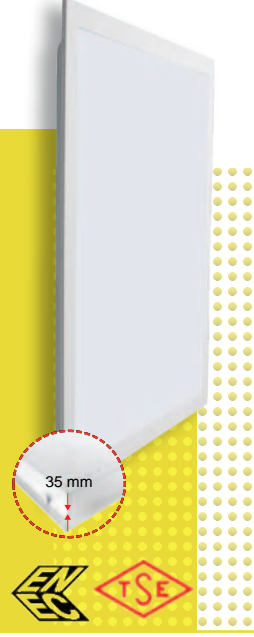

T3060243000-CL	30X60 Backlight Armatür 24W 3000K	10	31,00 \$
M3060243000-07	30X60 Backlight Armatür 24W 3000K A.K	10	71,00 \$
T3060244000-CL	30X60 Backlight Armatür 24W 4000K	10	31,00 \$
M3060244000-07	30X60 Backlight Armatür 24W 4000K, A.K	10	71,00 \$
T3060246500-CL	30X60 Backlight Armatür 24W 6500K	10	31,00 \$
M3060246500-07	30X60 Backlight Armatür 24W 6500K A.K	10	71,00 \$

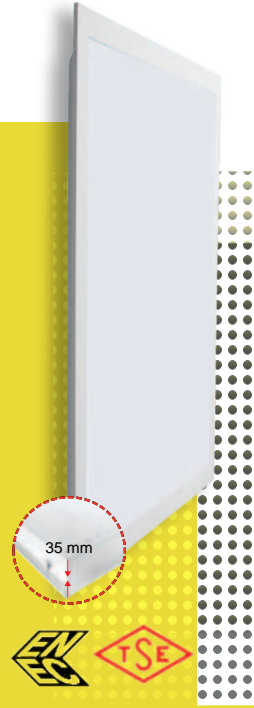

T3012236300-CL	30X120 Backlight Armatür 36W 3000K	10	40,00 \$
M3012236300-07	30X120 Backlight Armatür 36W 3000K A.K	10	80,00 \$
T3012236400-CL	30X120 Backlight Armatür 36W 4000K	10	40,00 \$
M3012236400-07	30X120 Backlight Armatür 36W 4000K, A.K	10	80,00 \$
T3012236650-CL	30X120 Backlight Armatür 36W 6500K	10	40,00 \$
M3012236500-07	30X120 Backlight Armatür 36W 6500K A.K	10	80,00 \$

BACKLIGHT ARMATÜRLER

KURUM ŞARTNAMESİNE UYGUN

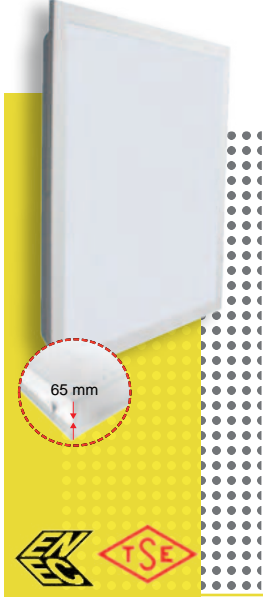

ÜRÜN KODU	ÜRÜN ADI	KOLİ AD.	FİYAT
M3030126560	30x30 Backlight Clip-in 6500K 12W	6	39,00 \$
M3030126561	30x30 Backlight Clip-in 6500K 12W A.K	6	79,00 \$
M3030126570	30x30 Backlight Sıva Üstü 6500K 12W	5	48,00 \$
M3030126571	30x30 Backlight Sıva Üstü 6500K 12W A.K	5	88,00 \$
M3030126580	30x30 Backlight Alçıpan 6500K 12W	6	40,00 \$
M3030126581	30x30 Backlight Alçıpan 6500K 12W A.K	6	80,00 \$
M3030126590	30x30 Backlight Sıva Altı 6500K 12W	6	37,00 \$
M3030126591	30x30 Backlight Sıva Altı 6500K 12W A.K	6	77,00 \$

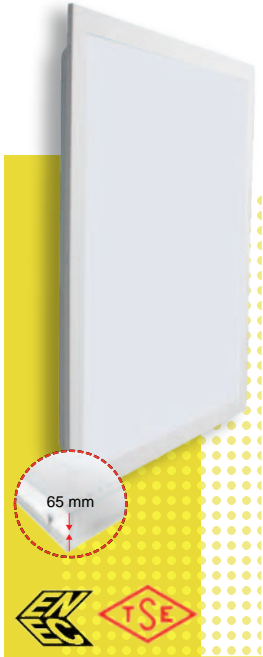

M6060366560	60x60 Backlight Clip-in 6500K 30W	6	84,00 \$
M6060366561	60x60 Backlight Clip-in 6500K 30W A.K	6	124,00 \$
M6060366570	60x60 Backlight Sıva Üstü 6500K 30W	5	91,00 \$
M6060366571	60x60 Backlight Sıva Üstü 6500K 30W A.K	5	131,00 \$
M6060366580	60x60 Backlight Alçıpan 6500K 30W	6	
M6060366581	60x60 Backlight Alçıpan 6500K 30W A.K	6	
M6060366590	60x60 Backlight Sıva Altı 6500K 30W	6	80,00 \$
M6060366591	60x60 Backlight Sıva Altı 6500K 30W A.K	6	120,00 \$

BACKLIGHT ARMATÜRLER

na·de®

AYDINLATMA ve ACİL
YÖNLENDİRME SİSTEMLERİ

KURUM ŞARTNAMESİNE UYGUN

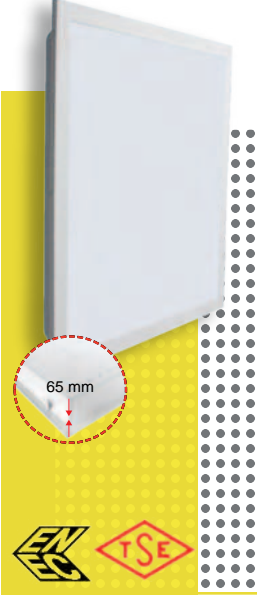

ÜRÜN KODU	ÜRÜN ADI	KOLİ AD.	FİYAT
M3030124060	30x30 Backlight Clip-in 4000K 12W	6	39,00 \$
M3030124061	30x30 Backlight Clip-in 4000K 12W A.K	6	79,00 \$
M3030124070	30x30 Backlight Sıva Üstü 4000K 12W	5	48,00 \$
M3030124071	30x30 Backlight Sıva Üstü 4000K 12W A.K	5	88,00 \$
M3030124080	30x30 Backlight Alçıpan 4000K 12W	6	40,00 \$
M3030124081	30x30 Backlight Alçıpan 4000K 12W A.K	6	80,00 \$
M3030124090	30x30 Backlight Sıva Altı 4000K 12W	6	37,00 \$
M3030124091	30x30 Backlight Sıva Altı 4000K 12W A.K	6	77,00 \$

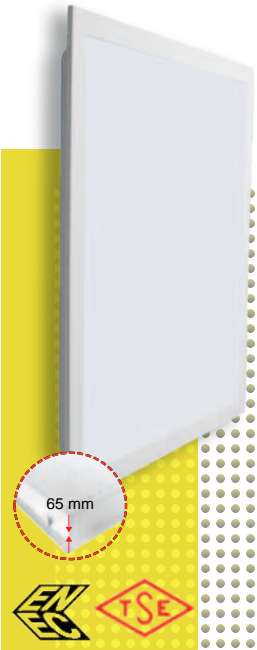

M6060364060	60x60 Backlight Clip-in 4000K 30W	6	84,00 \$
M6060364061	60x60 Backlight Clip-in 4000K 30W A.K	6	124,00 \$
M6060364070	60x60 Backlight Sıva Üstü 4000K 30W	5	91,00 \$
M6060364071	60x60 Backlight Sıva Üstü 4000K 30W A.K	5	131,00 \$
M6060364080	60x60 Backlight Alçıpan 4000K 30W	6	
M6060364081	60x60 Backlight Alçıpan 4000K 30W A.K	6	
M6060364090	60x60 Backlight Sıva Altı 4000K 30W	6	79,00 \$
M6060364091	60x60 Backlight Sıva Altı 4000K 30W A.K	6	119,00 \$



Đedal
EVPU

DMY Elektrik Otomasyon Aydınlatma San. ve Tic. A.Ş.
www.dmyeo.com.tr

DMY
ELEKTRİK OTOMASYON AYDINLATMA



BACKLIGHT ARMATÜRLER

STERİL ORTAM VE HASTANE ARMATÜRLERİ

ÜRÜN KODU

ÜRÜN ADI

KOLİ AD.

FİYAT

YENİ



M6060364050

60X60 Backlight Steril 36W 4000K

6

136,00 \$

YENİ



M3060204050

30X60 Backlight Steril 20W 4000K

6

129,00 \$

YENİ



M6060504040

60X60 Backlight Endirek 50W 4000K

6

93,00 \$

YENİ



M6060504050

60X60 Backlight Endirek Steril 50W 4000K

6

189,00 \$

YENİ



M2525184040

Kare Glop Armatür IP44 4000K

6

57,00 \$

M2525184041

Kare Glop Armatür IP44 4000K A.K

6

110,00 \$

M2525184042

Kare Glop Armatür IP44 4000K Sensörlü

6

61,00 \$

M2525184043

Kare Glop Armatür IP44 4000K Sensörlü A.K

6

115,00 \$

BACKLIGHT ARMATÜRLER

na·De®

AYDINLATMA ve AÇIL
YÖNLENDİRME SİSTEMLERİ

BACKLIGHT ÇERÇEVELERİ

ÜRÜN KODU

ÜRÜN ADI

KOLİ AD.

FİYAT

TAS3030

30x30 Backlight Sıva Üstü Çerçeve H:5cm

1

6,00 \$

TAS3031

30x30 Backlight Clip-in Çerçeve

1

5,00 \$

TAS6060

60x60 Backlight Sıva Üstü Çerçeve H:5cm

1

10,00 \$

TAS6061

60x60 Backlight Clip-in Çerçeve

1

7,00 \$

TAS3060

30x60 Backlight Sıva Üstü Çerçeve H:5cm

1

7,00 \$

TAS3061

30x60 Backlight Clip-in Çerçeve

1

6,00 \$

TAS30120

30x120 Backlight Sıva Üstü Çerçeve H:5cm

1

10,00 \$

TAS30121

30x120 Backlight Clip-in Çerçeve

1

8,00 \$

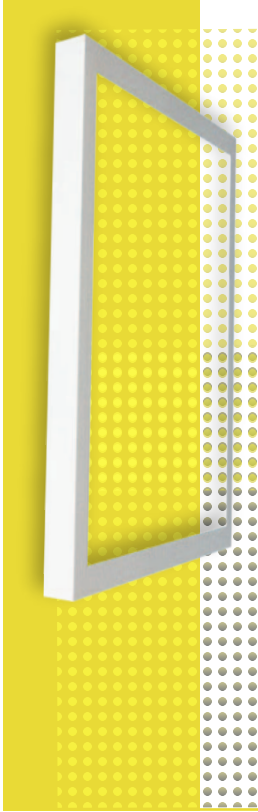

Backlight Armatür

Çerçevesi 30x30CM - 60x60CM - 30x60CM - 30x120CM



DOWNLIGHT ARMATÜRLER

CAPELLA

ÜRÜN KODU

ÜRÜN ADI

KOLİ AD.

FİYAT

M340309300000	Capella 3" Downlight 9W 3000K	1	30,00 \$
M340309300001	Capella 3" Downlight 9W 3000K A.K	1	70,00 \$
M340309400000	Capella 3" Downlight 9W 4000K	1	30,00 \$
M340309400001	Capella 3" Downlight 9W 4000K A.K	1	70,00 \$
M340309650000	Capella 3" Downlight 9W 6500K	1	30,00 \$
M340309650001	Capella 3" Downlight 9W "6500K A.K	1	70,00 \$



M340309300100	Capella 3" Downlight 9W 3000K PF>0,95	1	37,00 \$
M340309300101	Capella 3" Downlight 9W 3000K PF>0,95 A.K	1	77,00 \$
M340309400100	Capella 3" Downlight 9W 4000K PF>0,95	1	37,00 \$
M340309400101	Capella 3" Downlight 9W 4000K PF>0,95 A.K	1	77,00 \$
M340309650100	Capella 3" Downlight 9W 6500K PF>0,95	1	37,00 \$
M340309650101	Capella 3" Downlight 9W 6500K PF>0,95 A.K	1	77,00 \$



DOWNLIGHT ARMATÜRLER

na·De®

AYDINLATMA ve ACİL
YÖNLENDİRME SİSTEMLERİ

CAPELLA

ÜRÜN KODU

ÜRÜN ADI

KOLİ AD.

FİYAT

M340309300000-20	Capella 3" Downlight 9W 3000K IP	1	32,00 \$
M340309300000-21	Capella 3" Downlight 9W 3000K IP A.K	1	72,00 \$
M340309400000-20	Capella 3" Downlight 9W 4000K IP	1	32,00 \$
M340309400000-21	Capella 3" Downlight 9W 4000K IP A.K	1	72,00 \$
M340309650000-20	Capella 3" Downlight 9W 6500K IP	1	32,00 \$
M340309650000-21	Capella 3" Downlight 9W 6500K IP A.K	1	72,00 \$



M340309300000-50	Capella 3" Sıva Üstü Downlight 12W 3000K	1	43,00 \$
M340309300000-51	Capella 3" Sıva Üstü Downlight 12W 3000K A.K	1	83,00 \$
M340309400000-50	Capella 3" Sıva Üstü Downlight 12W 4000K	1	43,00 \$
M340309400000-51	Capella 3" Sıva Üstü Downlight 12W 4000K A.K	1	83,00 \$
M340309650000-50	Capella 3" Sıva Üstü Downlight 12W 6500K	1	43,00 \$
M340309650000-51	Capella 3" Sıva Üstü Downlight 12W 6500K A.K	1	83,00 \$

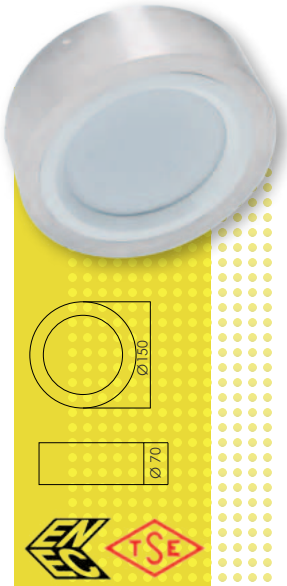

DMY Elektrik Otomasyon Aydınlatma San. ve Tic. A.Ş.
www.dmyeo.com.tr



DOWNLIGHT ARMATÜRLER

CAPELLA

ÜRÜN KODU

ÜRÜN ADI

KOLİ AD.

FİYAT

M340412300000

Capella 4" Downlight 12W 3000K

1

36,00 \$

M340412300001

Capella 4" Downlight 12W 3000K A.K

1

76,00 \$

M340412400000

Capella 4" Downlight 12W 4000K

1

36,00 \$

M340412400001

Capella 4" Downlight 12W 4000K A.K

1

76,00 \$

M340412650000

Capella 4" Downlight 12W 6500K

1

36,00 \$

M340412650001

Capella 4" Downlight 12W 6500K A.K

1

76,00 \$



M340412300100

Capella 4" Downlight 12W 3000K PF>0,95

1

44,00 \$

M340412300101

Capella 4" Downlight 12W 3000K PF>0,95 A.K

1

84,00 \$

M340412400100

Capella 4" Downlight 12W 4000K PF>0,95

1

44,00 \$

M340412400101

Capella 4" Downlight 12W 4000K PF>0,95 A.K

1

84,00 \$

M340412650100

Capella 4" Downlight 12W 6500K PF>0,95

1

44,00 \$

M340412650101

Capella 4" Downlight 12W 6500K PF>0,95 A.K

1

84,00 \$



DOWNLIGHT ARMATÜRLER

na·De®

AYDINLATMA ve ACİL
YÖNLENDİRME SİSTEMLERİ

CAPELLA

ÜRÜN KODU

ÜRÜN ADI

KOLİ AD.

FİYAT



M340412300000-20	Capella 4" Downlight 12W 3000K IP	1	39,00 \$
M340412300000-21	Capella 4" Downlight 12W 3000K IP A.K	1	79,00 \$
M340412400000-20	Capella 4" Downlight 12W 4000K IP	1	39,00 \$
M340412400000-21	Capella 4" Downlight 12W 4000K IP A.K	1	79,00 \$
M340412650000-20	Capella 4" Downlight 12W 6500K IP	1	39,00 \$
M340412650000-21	Capella 4" Downlight 12W 6500K IP A.K	1	79,00 \$

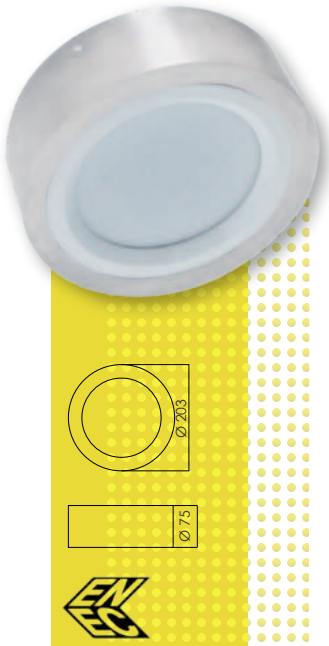

M340412300000-50	Capella 4" Sıva Üstü Downlight 12W 3000K	1	55,00 \$
M340412300000-51	Capella 4" Sıva Üstü Downlight 12W 3000K A.K	1	95,00 \$
M340412400000-50	Capella 4" Sıva Üstü Downlight 12W 4000K	1	55,00 \$
M340412400000-51	Capella 4" Sıva Üstü Downlight 12W 4000K A.K	1	95,00 \$
M340412650000-50	Capella 4" Sıva Üstü Downlight 12W 6500K	1	55,00 \$
M340412650000-51	Capella 4" Sıva Üstü Downlight 12W 6500K A.K	1	95,00 \$



DMY Elektrik Otomasyon Aydınlatma San. ve Tic. A.Ş.
www.dmyea.com.tr



27

DOWNLIGHT ARMATÜRLER

CAPELLA

ÜRÜN KODU

ÜRÜN ADI

KOLİ AD.

FİYAT

M340618300000

Capella 6" Downlight 18W 3000K

1

52,00 \$

M340618300001

Capella 6" Downlight 18W 3000K A.K

1

92,00 \$

M340618400000

Capella 6" Downlight 18W 4000K

1

52,00 \$

M340618400001

Capella 6" Downlight 18W 4000K A.K

1

92,00 \$

M340618650000

Capella 6" Downlight 18W 6500K

1

52,00 \$

M340618650001

Capella 6" Downlight 18W 6500K A.K

1

92,00 \$



M340618300100

Capella 6" Downlight 18W 3000K PF>0,95

1

60,00 \$

M340618300101

Capella 6" Downlight 18W 3000K PF>0,95 A.K

1

100,00 \$

M340618400100

Capella 6" Downlight 18W 4000K PF>0,95

1

60,00 \$

M340618400101

Capella 6" Downlight 18W 4000K PF>0,95 A.K

1

100,00 \$

M340618650100

Capella 6" Downlight 18W 6500K PF>0,95

1

60,00 \$

M340618650101

Capella 6" Downlight 18W 6500K PF>0,95 A.K

1

100,00 \$



DOWNLIGHT ARMATÜRLER

na·De®

AYDINLATMA ve ACİL
YÖNLENDİRME SİSTEMLERİ

CAPELLA

ÜRÜN KODU

ÜRÜN ADI

KOLİ AD.

FİYAT

M340618300000-20	Capella 6" Downlight 18W 3000K IP	1	56,00 \$
M340618300000-21	Capella 6" Downlight 18W 3000K IP A.K	1	96,00 \$
M340618400000-20	Capella 6" Downlight 18W 4000K IP	1	56,00 \$
M340618400000-21	Capella 6" Downlight 18W 4000K IP A.K	1	96,00 \$
M340618650000-20	Capella 6" Downlight 18W 6500K IP	1	56,00 \$
M340618650000-21	Capella 6" Downlight 18W 6500K IP A.K	1	96,00 \$



M340618300000-50	Capella 6" Siva Üstü Downlight 12W 3000K	1	75,00 \$
M340618300000-51	Capella 6" Siva Üstü Downlight 12W 3000K A.K	1	115,00 \$
M340618400000-50	Capella 6" Siva Üstü Downlight 12W 4000K	1	75,00 \$
M340618400000-51	Capella 6" Siva Üstü Downlight 12W 4000K A.K	1	115,00 \$
M340618650000-50	Capella 6" Siva Üstü Downlight 12W 6500K	1	75,00 \$
M340618650000-51	Capella 6" Siva Üstü Downlight 12W 6500K A.K	1	115,00 \$

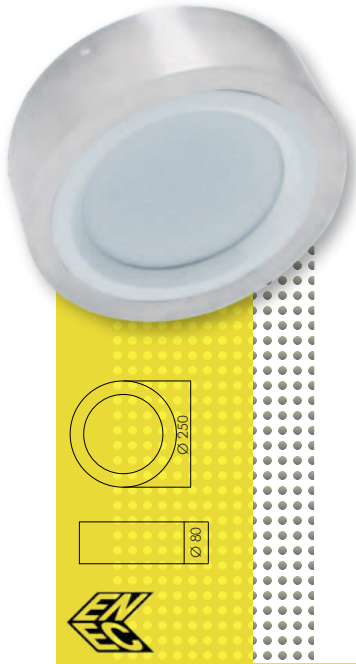

DMY Elektrik Otomasyon Aydınlatma San. ve Tic. A.Ş.
www.dmyeo.com.tr



DOWNLIGHT ARMATÜRLER

MIASA

ÜRÜN KODU

ÜRÜN ADI

KOLİ AD.

FİYAT

M300601730000

Miasa 6" Sıva Altı Downlight 17,5W 3000K

1

50,00 \$

M300601730001

Miasa 6" Sıva Altı Downlight 17,5W 3000K A.K

1

90,00 \$

M300601740000

Miasa 6" Sıva Altı Downlight 17,5W 4000K

1

50,00 \$

M300601740001

Miasa 6" Sıva Altı Downlight 17,5W 4000K A.K

1

90,00 \$

M300601765000

Miasa 6" Sıva Altı Downlight 17,5W 6500K

1

50,00 \$

M300601765001

Miasa 6" Sıva Altı Downlight 17,5W 6500K A.K

1

90,00 \$



Φ 150mm

M308202030010

Miasa 8" Sıva Altı Downlight 20W 3000K

1

72,00 \$

M308202030011

Miasa 8" Sıva Altı Downlight 20W 3000K A.K

1

112,00 \$

M308202040010

Miasa 8" Sıva Altı Downlight 20W 4000K

1

72,00 \$

M308202040011

Miasa 8" Sıva Altı Downlight 20W 4000K A.K

1

112,00 \$

M308202065010

Miasa 8" Sıva Altı Downlight 20W 6500K

1

72,00 \$

M308202065011

Miasa 8" Sıva Altı Downlight 20W 6500K,A.K

1

112,00 \$



Φ 210mm

LED SPOT ARMATÜRLERİ

MERGA

ÜRÜN KODU

ÜRÜN ADI

KOLİ AD.

FİYAT

YENİ

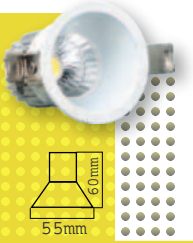

φ50mm

55mm

M360108400000

Merga Mini Led Spot Oval RAL9016 4000K 4.5W

-

26,00 \$

YENİ

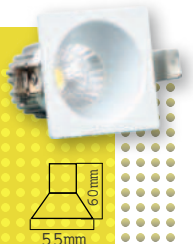

φ50mm

55mm

M360108401000

MERGA Mini Led Spot Kare RAL9016 4000K 4.5W

-

26,00 \$

YENİ



φ80mm

90mm

M360045400000

Merga Midi GU10 Spot Oval RAL9016 4000K 8W

-

17,00 \$

YENİ



φ80mm

90mm

M360045401000

Merga Midi GU10 Spot Kare RAL9016 4000K 8W

-

17,00 \$

YENİ

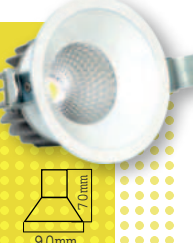

φ80mm

90mm

M360012400000

Merga Midi Led Spot Oval RAL9016 4000K 12W

-

32,00 \$

YENİ



φ80mm

90mm

M360012401000

Merga Midi Led Spot Kare RAL9016 4000K 12W

-

32,00 \$

LINEER ARMATÜRLER

LIARA



ÜRÜN KODU	ÜRÜN ADI	KOLİ AD.	FİYAT
M541000301000	Liara Lineer Sarkıt Armatür 50x72 100cm 30W 3000K	1	62,00 \$
M541000401000	Liara Lineer Sarkıt Armatür 50x72 100cm 30W 4000K	1	62,00 \$
M541000651000	Liara Lineer Sarkıt Armatür 50x72 100cm 30W 6500K	1	62,00 \$
M541500301000	Liara Lineer Sarkıt Armatür 50x72 150cm 40W 3000K	1	85,00 \$
M541500401000	Liara Lineer Sarkıt Armatür 50x72 150cm 40W 4000K	1	85,00 \$
M541500651000	Liara Lineer Sarkıt Armatür 50x72 150cm 40W 6500K	1	85,00 \$
M542000301000	Liara Lineer Sarkıt Armatür 50x72 200cm 60W 3000K	1	123,00 \$
M542000401000	Liara Lineer Sarkıt Armatür 50x72 200cm 60W 4000K	1	123,00 \$
M542000651000	Liara Lineer Sarkıt Armatür 50x72 200cm 60W 6500K	1	123,00 \$

APARAT SEÇENEKLERİ

TAS1461	Halatlı Askı Aparatı 1mt	1	3,00 \$
TAS1462	Baffle Tavan Aparatı	1	6,00 \$

LINEER ARMATÜRLERİ

LIARA

ÜRÜN KODU

ÜRÜN ADI

KOLİ AD.

FİYAT

M551000301000

Liara Linear Sarkıt Armatür 85x100 100cm 90W

1

126,00 \$

M551000401000

Liara Linear Sarkıt Armatür 85x100 100cm 90W
4000K

1

126,00 \$

M551000651000

Liara Linear Sarkıt Armatür 85x100 100cm 90W
6500K

1

126,00 \$

M551500301000

Liara Linear Sarkıt Armatür 85x100 150cm 120W
3000K

1

179,00 \$

M551500401000

Liara Linear Sarkıt Armatür 85x100 150cm 120W
4000K

1

179,00 \$

M551500651000

Liara Linear Sarkıt Armatür 85x100 150cm 120W
6500K

1

179,00 \$

M552000301000

Liara Linear Sarkıt Armatür 85x100 200cm 150W
3000K

1

222,00 \$

M552000401000

Liara Linear Sarkıt Armatür 85x100 200cm 150W
4000K

1

222,00 \$

M552000651000

Liara Linear Sarkıt Armatür 85x100 200cm 150W
6500K

1

222,00 \$



Liara 30W - 150W

Linear Sarkıt Armatür

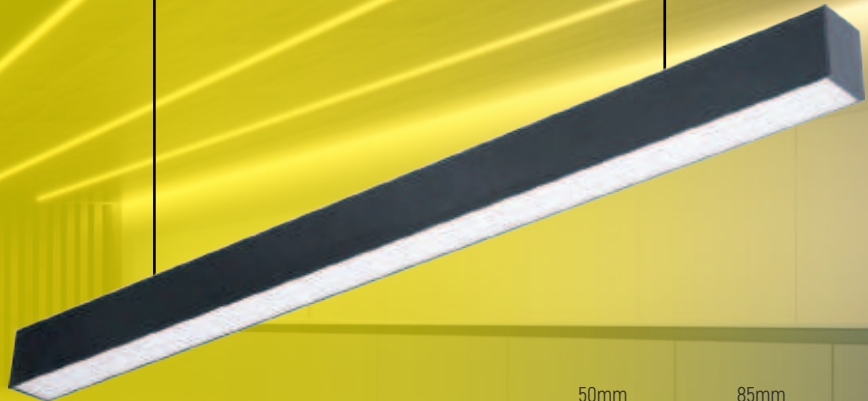

72mm



100mm



DUVAR / TAVAN ARMATÜRLERİ

AYDINLATMA ARMATÜRÜ

ÜRÜN KODU

ÜRÜN ADI

KOLİ AD.

FİYAT



10955

1xE27 Duylu Tavan Armatürü

9

44,00 \$



10956.03

Ledli Tavan Armatürü 12W 3000K

9

56,00 \$

10956.04

Ledli Tavan Armatürü 12W 4000K

9

56,00 \$

10956

Ledli Tavan Armatürü 12W 6500K

9

56,00 \$



10957.03

Acilli Ledli Tavan Armatürü 12W 3000K

9

69,00 \$

10957.04

Acilli Ledli Tavan Armatürü 12W 4000K

9

69,00 \$

10957

Acilli Ledli Tavan Armatürü 12W 6500K

9

69,00 \$



ND1024-12-03

Ledli Tavan Armatürü 12W 6500K

14

18,00 \$

ND1024.Ö

Ledli Tavan Armatürü 20W 4000K PF>0,95

14

25,00 \$

***Özel Kodlu Ürünlerde ENEC Belgeli Driver Kullanılmaktadır.

DUVAR / TAVAN ARMATÜRLERİ

AYDINLATMA ARMATÜRÜ

ÜRÜN KODU	ÜRÜN ADI	KOLİ AD.	FİYAT
10972.03	Ledli Tavan Armatürü 3000K	10	86,00 \$
10972.04	Ledli Tavan Armatürü 4000K	10	86,00 \$
10972	Ledli Tavan Armatürü 6500K	10	86,00 \$

***Özel Kodlu Ürünlerde ENEC Belgeli Driver Kullanılmaktadır.

10973.03	Acilli Ledli Tavan Armatürü 3000K	10	121,00 \$
10973.04	Acilli Ledli Tavan Armatürü 4000K	10	121,00 \$
10973	Acilli Ledli Tavan Armatür 6500K	10	121,00 \$

***Özel Kodlu Ürünlerde ENEC Belgeli Driver Kullanılmaktadır.

NDTA10220-PD-03	2xE27 Porselen Duyulu Tavan Armatürü	14	14,00 \$
NDTA10220-K-TPD-03	2xE27 Porselen Duyulu Tavan Armatürü Krom	14	23,00 \$
NDTA10220-TPD-03	1xE27 Porselen Duyulu Tavan Armatürü	14	11,00 \$

10805	1xE27 Duvar Armatürü	8	42,00 \$
-------	----------------------	---	----------

10306	Ledli Tavan Armatürü Yuvarlak Glob	8	10,00 \$
-------	------------------------------------	---	----------

DUVAR / TAVAN ARMATÜRLERİ

AYDINLATMA ARMATÜRÜ

ÜRÜN KODU

ÜRÜN ADI

KOLİ AD.

FİYAT

YENİ



10202

1xE27 Duyulu Sensörsüz Duvar Armatürü

21

19,00 \$

10204

Ledli Duvar Armatürü 6500K

21

25,00 \$

10205

Ledli Duvar Armatürü 6500K PF>0,95

21

35,00 \$



TA 10430 KROM

2xE27 Duyulu Tavan Armatürü Krom

8

49,00 \$

TA 10430

2xE27 Duyulu Tavan Armatürü

8

42,00 \$

YENİ



ND10985.Ö

Tavan ARM. 12W 4000K Difüzörlü

8

38,00 \$

YENİ



ND10965.Ö

Tavan ARM. 12W 4000K PF 0,95 Düz Cam

8

27,00 \$

YENİ



ND10969.Ö

Tavan ARM. 20W 4000 PF 0,95 Difüzör

8

34,00 \$

LEDLİ BANT VE ETANJ ARMATÜRLERİ

BANT ARMATÜRLERİ

ÜRÜN KODU	ÜRÜN ADI	KOLİ AD.	FİYAT
T2218300000	Ledli Bant Armatürü Sıva Üstü 60cm 18W 3000K	60	7,00 \$
T2218400000	Ledli Bant Armatürü Sıva Üstü 60cm 18W 4000K	60	7,00 \$
T2218650000	Ledli Bant Armatürü Sıva Üstü 60cm 18W 6500K	60	7,00 \$
T2236300000	Ledli Bant Armatürü 120cm Sıva Üstü 36W 3000K	30	8,00 \$
T2236400000	Ledli Bant Armatürü 120cm Sıva Üstü 36W 4000K	30	8,00 \$
T2236650000	Ledli Bant Armatürü 120cm Sıva Üstü 36W 6500K	30	8,00 \$

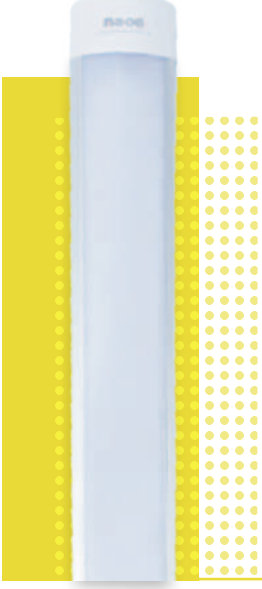

ETANJ ARMATÜRLERİ

T4218300000	Ledli Etanj Armatür Sıva Üstü 60cm 18W 3000K	30	19,00 \$
T4218400000	Ledli Etanj Armatür Sıva Üstü 60cm 18W 4000K	30	19,00 \$
T4218650000	Ledli Etanj Armatür Sıva Üstü 60cm 18W 6500K	30	19,00 \$
T4236300000	Ledli Etanj Armatür 120cm Sıva Üstü 36W 3000K	15	23,00 \$
T4236400000	Ledli Etanj Armatür 120cm Sıva Üstü 36W 4000K	15	23,00 \$
T4236650000	Ledli Etanj Armatür 120cm Sıva Üstü 36W 6500K	15	23,00 \$



ETANJ ARMATÜRLERİ

MEISSA-F7

ÜRÜN KODU

ÜRÜN ADI

KOLİ AD.

FİYAT

"Alüminyum
Etanj
Armatür"

M270603020010

Meissa F7 Etanj Armatür 60cm 20W 3000K IP

1

38,00 \$

M270603020011

Meissa F7 Etanj Armatür 60cm 20W 3000K IP A.K

1

78,00 \$

M270604020010

Meissa F7 Etanj Armatür 60cm 20W 4000K IP

1

38,00 \$

M270604020011

Meissa F7 Etanj Armatür 60cm 20W 4000K IP A.K

1

78,00 \$

M270606520010

Meissa F7 Etanj Armatür 60cm 20W 6500K IP

1

38,00 \$

M270606520011

Meissa F7 Etanj Armatür 60cm 20W 6500K IP A.K

1

78,00 \$

M271203040010

Meissa F7 Etanj Armatür 120cm 40W 3000K IP
PF>0,95

1

57,00 \$

M271203040011

Meissa F7 Etanj Armatür 120cm 40W 3000K IP
PF>0,95 A.K

1

97,00 \$

M271204040010

Meissa F7 Etanj Armatür 120cm 40W 4000K IP
PF>0,95

1

57,00 \$

M271204040011

Meissa F7 Etanj Armatür 120cm 40W 4000K IP
PF>0,95 A.K

1

97,00 \$

M271206540010

Meissa F7 Etanj Armatür 120cm 40W 6500K IP
PF>0,95

1

57,00 \$

M271206540011

Meissa F7 Etanj Armatür 120cm 40W 6500K IP
PF>0,95 A.K

1

97,00 \$



***Kurum şartnamelerine uygundur.

ETANJ ARMATÜRLERİ

IND ECO

ÜRÜN KODU

ÜRÜN ADI

KOLİ AD.

FİYAT

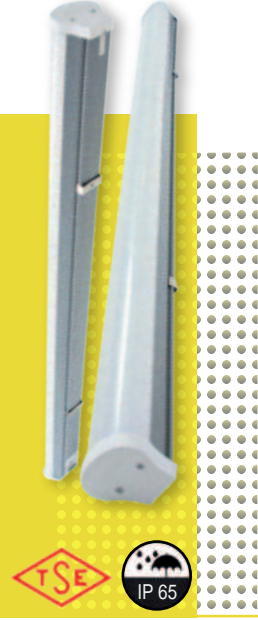

M291201404020-10	IND Eco Etanj Armatür 40W 120cm 4000K	1	38,00 \$
M291201404020-11	IND Eco Etanj Armatür 40W 120cm 4000K A.K	1	78,00 \$
M291201654020-10	IND Eco Etanj Armatür 40W 120cm 6500K	1	38,00 \$
M291201654020-11	IND Eco Etanj Armatür 40W 120cm 6500K A.K	1	78,00 \$

IND PLUS

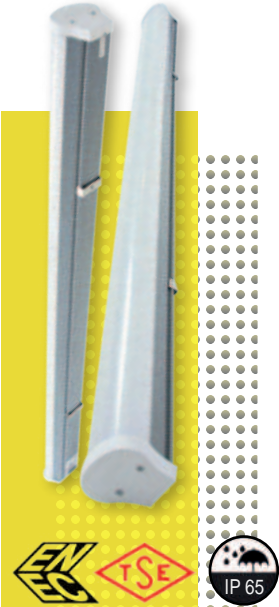

M291201404010	IND Plus Etanj Armatür 40W 120cm 4000K	1	46,00 \$
M291201404011	IND Plus Etanj Armatür 40W 120cm 4000K A.K	1	86,00 \$
M291201654010	IND Plus Etanj Armatür 40W 120cm 6500K	1	46,00 \$
M291201654011	IND Plus Etanj Armatür 40W 120cm 6500K A.K	1	86,00 \$
M291201406010	IND Plus Etanj Armatür 60W 120cm 4000K	1	67,00 \$
M291201406011	IND Plus Etanj Armatür 60W 120cm 4000K A.K	1	107,00 \$
M291201656010	IND Plus Etanj Armatür 60W 120cm 6500K	1	67,00 \$
M291201656011	IND Plus Etanj Armatür 60W 120cm 6500K A.K	1	107,00 \$

***Bu Gruptaki Ürünler IP65 Özelliği Taşımaktadır.

ETANJ ARMATÜRLERİ

IND

ÜRÜN KODU

ÜRÜN ADI

KOLİ AD.

FİYAT

M290601302000	IND Etanj Armatür 20W 60cm 3000K	1	27,00 \$
M290601302001	IND Etanj Armatür 20W 60cm 3000K A.K	1	67,00 \$
M290601402000	IND Etanj Armatür 20W 60cm 4000K	1	27,00 \$
M290601402001	IND Etanj Armatür 20W 60cm 4000K A.K	1	67,00 \$
M290601652000	IND Etanj Armatür 20W 60cm 6500K	1	27,00 \$
M290601652001	IND Etanj Armatür 20W 60cm 6500K A.K	1	67,00 \$
M291201304000-10	IND Etanj Armatür 40W 120cm 3000K	1	40,00 \$
M291201304000-11	IND Etanj Armatür 40W 120cm 3000K A.K	1	80,00 \$
M291201404000-10	IND Etanj Armatür 40W 120cm 4000K	1	40,00 \$
M291201404000-11	IND Etanj Armatür 40W 120cm 4000K A.K	1	80,00 \$
M291201654000-10	IND Etanj Armatür 40W 120cm 6500K	1	40,00 \$
M291201654000-11	IND Etanj Armatür 40W 120cm 6500K A.K	1	80,00 \$



ETANJ ARMATÜRLERİ

IND RADAR SENSÖRLÜ

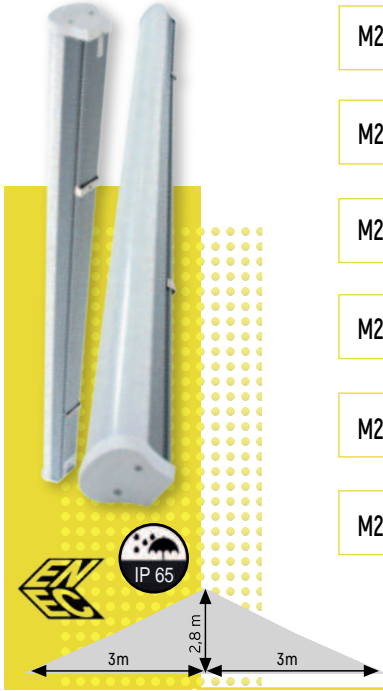

ÜRÜN KODU	ÜRÜN ADI	KOLİ AD.	FİYAT
M291201304040	IND Etanj Armatür 40W 120cm 3000K Radarlı	1	48,00 \$
M291201304041	IND Etanj Armatür 40W 120cm 3000K Radarlı A.K	1	88,00 \$
M291201404040	IND Etanj Armatür 40W 120cm 4000K Radarlı	1	48,00 \$
M291201404041	IND Etanj Armatür 40W 120cm 4000K Radarlı A.K	1	88,00 \$
M291201654040	IND Etanj Armatür 40W 120cm 6500K Radarlı	1	48,00 \$
M291201654041	IND Etanj Armatür 40W 120cm 6500K Radarlı A.K	1	88,00 \$

IND KORİDOR FONKSİYONLU

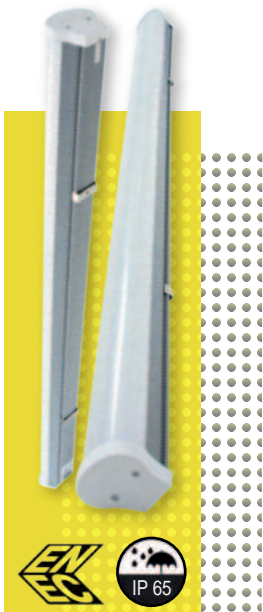

M291201404098	IND Etanj Armatür Koridor Fonksiyonlu 40W 120cm 4000K	1	93,00 \$
M291201404099	IND Etanj Armatür Koridor Fonksiyonlu 40W 120cm 4000K A.K	1	133,00 \$
M291201654098	IND Etanj Armatür Koridor Fonksiyonlu 40W 120cm 6500K	1	93,00 \$
M291201654099	IND Etanj Armatür Koridor Fonksiyonlu 40W 120cm 6500K A.K	1	133,00 \$

ETANJ ARMATÜRLERİ

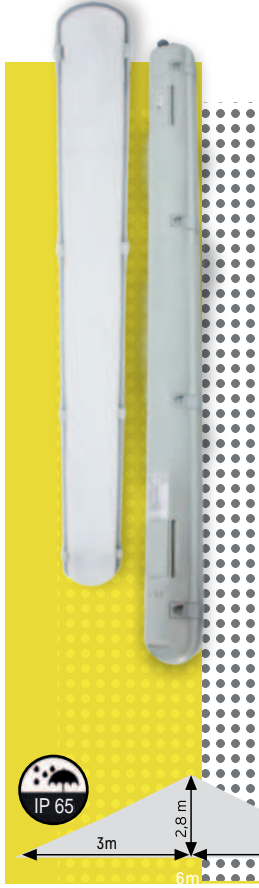

SITULA

ÜRÜN KODU

ÜRÜN ADI

KOLİ AD.

FİYAT

109.01.3414-K3	Situla Siva Üstü Etanj Armatür 40W 4000K	1	69,00 \$
109.01.3414-K3-3H	Situla Siva Üstü Etanj Armatür 40W 4000K A.K	1	123,00 \$
109.01.3414-K3-R	Situla Siva Üstü Etanj Armatür 40W 4000K Radarlı	1	82,00 \$
109.01.3414-K3-3H-R	Situla Siva Üstü Etanj Armatür 40W 4000K Radarlı A.K	1	133,00 \$
109.01.3416-K3	Situla Siva Üstü Etanj Armatür 40W 6500K	1	69,00 \$
109.01.3416-K3-3H	Situla Siva Üstü Etanj Armatür 40W 6500K A.K	1	123,00 \$
109.01.3416-K3-R	Situla Siva Üstü Etanj Armatür 40W 6500K Radarlı	1	82,00 \$
109.01.3416-K3-3H-R	Situla Siva Üstü Etanj Armatür 40W 6500K Radarlı A.K	1	133,00 \$

EXPROOF

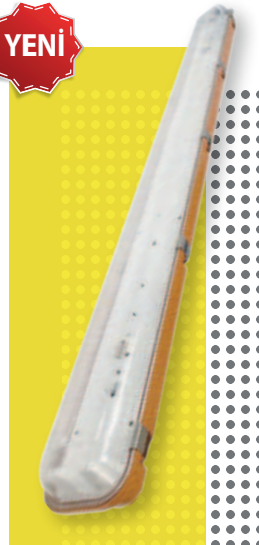

T9910000496	Exproof Siva Üstü Led Etanj Armatür 40W 6500K	1	119,00 \$
T9910000497	Exproof Siva Üstü Led Etanj Armatür 40W 6500K A.K	1	162,00 \$
T9910000498	Exproof Siva Üstü Led Etanj Armatür 40W 4000K	1	119,00 \$
T9910000499	Exproof Siva Üstü Led Etanj Armatür 40W 4000K A.K	1	162,00 \$

ETANJ ARMATÜRLERİ

CHARA

ÜRÜN KODU

ÜRÜN ADI

KOLİ AD.

FİYAT

YENİ



M806010401600

Chara Ralina 10W 60cm 4000K

-

52,00 \$

YENİ



M806010401601

Chara Ralina 10W 55cm 4000K 1 Prizli

-

58,00 \$

YENİ



M806010401602

Chara Ralina 10W 50cm 4000K 2 Prizli

-

64,00 \$

MEISSA



M806063401600

Meissa Ralina 18W 60cm 4000K

30

25,00 \$

YENİ



M271202040000

Meissa Ralina 20W 120CM 4000K Anahtarlı

30

59,00 \$

WALLWASHER

LINEPOWER

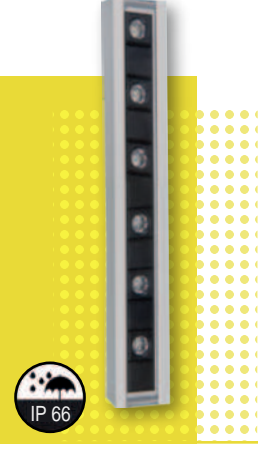

ÜRÜN KODU	ÜRÜN ADI	KOLİ AD.	FİYAT
M220320401000	Linepower Classic Wallwasher 7W 32cm 4000K	1	123,00 \$
M220620401000	Linepower Classic Wallwasher 14W 62cm 4000K	1	185,00 \$
M220920401000	Linepower Classic Wallwasher 21W 92cm 4000K	1	206,00 \$
M221220401000	Linepower Classic Wallwasher 28W 122cm 4000K	1	280,00 \$

***Farklı Işık Renk seçenekleri için Satış Temsilcisine Danışınız.

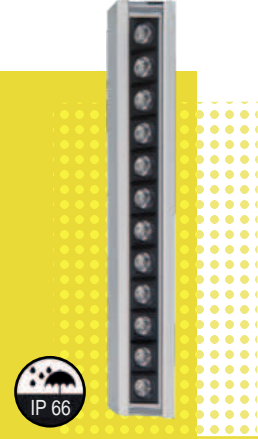

M220321401000	Linepower Plus Wallwasher 14W 32cm 4000K	1	122,00 \$
M220621401000	Linepower Plus Wallwasher 28W 62cm 4000K	1	180,00 \$
M220921401000	Linepower Plus Wallwasher 42W 92cm 4000K	1	234,00 \$
M221221401000	Linepower Plus Wallwasher 56W 122cm 4000K	1	275,00 \$

***Farklı Işık Renk seçenekleri için Satış Temsilcisine Danışınız.

LINEPOWER RGB

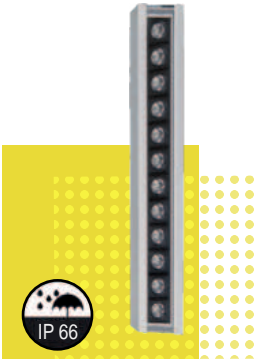

M220621051000	Linepower Plus Wallwasher 62cm RGB	1	338,00 \$
M220921051000	Linepower Plus Wallwasher 92cm RGB	1	417,00 \$
M221221051000	Linepower Plus Wallwasher 122cm RGB	1	469,00 \$

***Farklı Işık Renk seçenekleri için Satış Temsilcisine Danışınız.

WALLWASHER

na·De®

AYDINLATMA ve AÇIL
YÖNLENDİRME SİSTEMLERİ

EVALINE

ÜRÜN KODU

ÜRÜN ADI

KOLİ AD.

FİYAT



IP20

M210320401000	Evaline Classic Wallwasher 7W 32cm 4000K	1	83,00 \$
M210620401000	Evaline Classic Wallwasher 14W 62cm 4000K	1	131,00 \$
M210920401000	Evaline Classic Wallwasher 21W 92cm 4000K	1	167,00 \$
M211220401000	Evaline Classic Wallwasher 28W 122cm 4000K	1	191,00 \$

***Farklı Işık Renk seçenekleri için Satış Temsilcisine Danışınız.



IP20

M210321401000	Evaline Plus Wallwasher 14W 32cm 4000K	1	92,00 \$
M210621401000	Evaline Plus Wallwasher 28W 62cm 4000K	1	137,00 \$
M210921401000	Evaline Plus Wallwasher 42W 92cm 4000K	1	188,00 \$
M211221401000	Evaline Plus Wallwasher 56W 122cm 4000K	1	193,00 \$

***Farklı Işık Renk seçenekleri için Satış Temsilcisine Danışınız.

EVALINE RGB



IP20

M210621051000	Evaline Plus Wallwasher 62cm RGB	1	274,00 \$
M210921051000	Evaline Plus Wallwasher 92cm RGB	1	378,00 \$
M210221051000	Evaline Plus Wallwasher 122cm RGB	1	410,00 \$

***Farklı Işık Renk seçenekleri için Satış Temsilcisine Danışınız.



DMY Elektrik Otomasyon Aydınlatma San. ve Tic. A.Ş.
www.dmyea.com.tr



45

YÜKSEK TAVAN ARMATÜRLERİ

na·De®

LINATRUNK

ÜRÜN KODU

ÜRÜN ADI

KOLİ AD.

FİYAT

Linatrunk 80W - 120W

Yüksek Tavan Armatürü



YENİ



LINATRUNK AKRİLİK

M261206512101

Linatrunk 120W 120cm 6500K Akriik Lensli PF>0,95

1

181,00 \$

LINATRUNK CAMLI

M261206512001

Linatrunk 120W 120cm 6500K Camlı Lensli PF>0,95

1

194,00 \$

YÜKSEK TAVAN ARMATÜRLERİ

na·De®

AYDINLATMA ve ACİL
YÖNLENDİRME SİSTEMLERİ

LINATRUNK

ÜRÜN KODU

ÜRÜN ADI

KOLİ AD.

FİYAT

YENİ



LINATRUNK AKRİLİK

M261206508100	Linatrunk 80W 120cm 6500K Akrilik Lenssiz PF>0,95	1	109,00 \$
M261206509100	Linatrunk 90W 120cm 6500K Akrilik Lenssiz PF>0,95	1	121,00 \$
M261206511100	Linatrunk 110W 120cm 6500K Akrilik Lenssiz PF>0,95	1	126,00 \$
M261206512110	Linatrunk 120W 120cm 6500K Akrilik Lenssiz PF>0,95	1	146,00 \$

LINATRUNK CAMLI

M261206508000	Linatrunk 80W 120cm 6500K Camlı Lenssiz PF>0,95	1	123,00 \$
M261206509000	Linatrunk 90W 120cm 6500K Camlı Lenssiz PF>0,95	1	136,00 \$
M261206511000	Linatrunk 110W 120cm 6500K Camlı Lenssiz PF>0,95	1	140,00 \$
M261206512010	Linatrunk 120W 120cm 6500K Camlı Lenssiz PF>0,95	1	159,00 \$



DMY Elektrik Otomasyon Aydınlatma San. ve Tic. A.Ş.
www.dmyea.com.tr



YÜKSEK TAVAN ARMATÜRLERİ

na·De®

HIGHBAY

ÜRÜN KODU

ÜRÜN ADI

KOLİ AD.

FİYAT



T5010065100

Yüksek Tavan Armatürü 100W 6500K

1

112,00 \$

T5015065100

Yüksek Tavan Armatürü 150W 6500K

1

154,00 \$

T5020065100

Yüksek Tavan Armatürü 200W 6500K

1

201,00 \$

M250553010000

High Bay Yüksek Tavan 60W 55cm 3000K

1

152,00 \$

M250554010000

High Bay Yüksek Tavan 60W 55cm 4000K

1

152,00 \$

M250556510000

High Bay Yüksek Tavan 60W 55cm 6500K

1

152,00 \$

M251053010000

High Bay Yüksek Tavan 120W 105cm 3000K

1

236,00 \$

M251054010000

High Bay Yüksek Tavan 120W 105cm 4000K

1

236,00 \$

M251056510000

High Bay Yüksek Tavan 120W 105cm 6500K

1

236,00 \$

M251553010000

High Bay Yüksek Tavan 160W 155cm 3000K

1

296,00 \$

M251554010000

High Bay Yüksek Tavan 160W 155cm 4000K

1

296,00 \$

M251556510000

High Bay Yüksek Tavan 160W 155cm 6500K

1

296,00 \$



YÜKSEK TAVAN ARMATÜRLERİ

na·De®

AYDINLATMA ve ACİL
YÖNLENDİRME SİSTEMLERİ

KANOPI ARMATÜRLERİ

ÜRÜN KODU

ÜRÜN ADI

KOLİ AD.

FİYAT



M100856531100

Mira 3 Projektör 85W 6500K Beyaz

1

162,00 \$

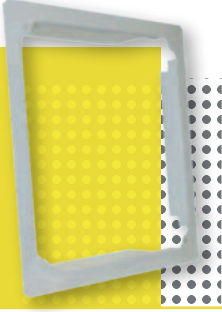

M990101400000

Mira 3, Ankaştre Beyaz 40x40 cm
Dış 34x34 cm İç Takım

1

33,00 \$



M990756520000

Mira 3 Tonoz Armatür 75W 6500K Beyaz

1

235,00 \$



INDULINA

ÜRÜN KODU

ÜRÜN ADI

KOLİ AD.

FİYAT

Indulina 300W - 2400W

Yüksek Güçlü Led Projektörler

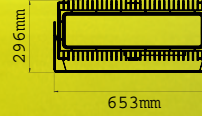
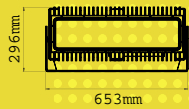
**YENİ**

M153006500000

Projektör Indulina 300W 6500K 60 Derece

1

1081,00 \$

M154006500000

Projektör Indulina 400W 6500K 60 Derece

1

1081,00 \$

M155006500000

Projektör Indulina 500W 6500K 60 Derece

1

1.220,00 \$

M156004000000

Projektör Indulina 600W 6500K 60 Derece

1

1.220,00 \$

INDULINA

ÜRÜN KODU

ÜRÜN ADI

KOLİ AD.

FİYAT

YENİ



M151200650000

Projektör Indulina 1200W 6500K 60 Derece

1

FİYAT
SORUNUZ

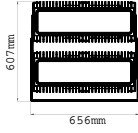

YENİ



M151800650000

Projektör Indulina 1800W 6500K 60 Derece

1

FİYAT
SORUNUZ

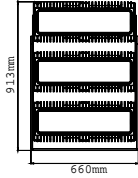

YENİ



M152400650000

Projektör Indulina 2400W 6500K 60 Derece

1

FİYAT
SORUNUZ

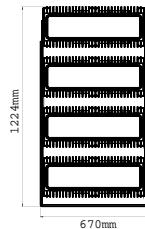

PROJEKTÖRLER

na·De®

MIKRA

ÜRÜN KODU

ÜRÜN ADI

KOLİ AD.

FİYAT

YENİ



M142006500000

Mikra Gen-3 200W 6500K Siyah 120C

1

320,00 \$

M142506500000

Mikra Gen-3 250W 6500K Siyah 120C

1

367,00 \$

M143006500000

Mikra Gen-3 300W 6500K Siyah 120C

1

366,00 \$



M141006520000

Mikra Gen-3 Projektör 100W 6500K

1

221,00 \$

M141506520000

Mikra Gen-3 Projektör 150W 6500K

1

242,00 \$



GRASSIAS

T9965030000

Grassias Slim Led Projektör 30W 6500K

1

20,00 \$

T9965050000

Grassias Slim Led Projektör 50W 6500K

1

25,00 \$

T9965100000

Grassias Slim Led Projektör 100W 6500K

1

45,00 \$

T9965150000

Grassias Slim Led Projektör 150W 6500K

1

75,00 \$

T9965200000

Grassias Slim Led Projektör 200W 6500K

1

95,00 \$



SOLAR AYDINLATMA

SAVLIGHT

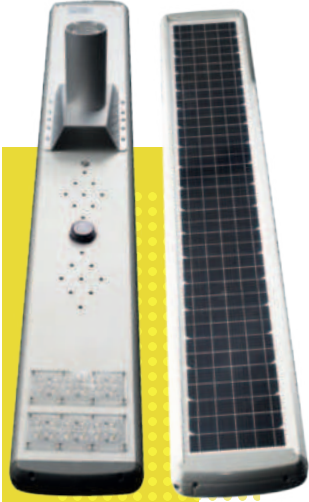

ÜRÜN KODU	ÜRÜN ADI	KOLİ AD.	FİYAT
SAVLIGHT 40	Solar Sokak Aydınlatma 40W 4000K	1	FİYAT SORUNUZ
SAVLIGHT 50	Solar Sokak Aydınlatma 50W 4000K	1	FİYAT SORUNUZ
SAVLIGHT 60	Solar Sokak Aydınlatma 60W 4000K	1	FİYAT SORUNUZ
SAVLIGHT 80	Solar Sokak Aydınlatma 80W 4000K	1	FİYAT SORUNUZ
SAVLIGHT 90	Solar Sokak Aydınlatma 90W 4000K	1	FİYAT SORUNUZ
SAVLIGHT 100	Solar Sokak Aydınlatma 100W 4000K	1	FİYAT SORUNUZ
SAVLIGHT 120	Solar Sokak Aydınlatma 120W 4000K	1	FİYAT SORUNUZ

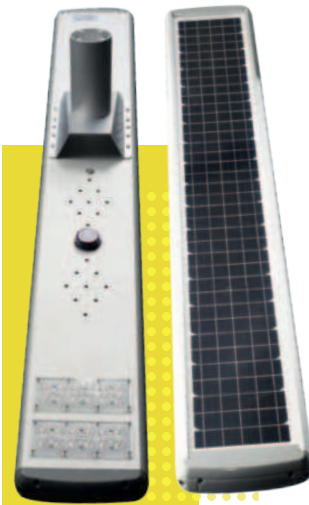

SAVLIGHT 40/A-C	Solar Sokak Aydınlatma 40W 4000K	1	FİYAT SORUNUZ
SAVLIGHT 50/A-C	Solar Sokak Aydınlatma 50W 4000K	1	FİYAT SORUNUZ
SAVLIGHT 60/A-C	Solar Sokak Aydınlatma 60W 4000K	1	FİYAT SORUNUZ
SAVLIGHT 80/A-C	Solar Sokak Aydınlatma 80W 4000K	1	FİYAT SORUNUZ
SAVLIGHT 90/A-C	Solar Sokak Aydınlatma 90W 4000K	1	FİYAT SORUNUZ
SAVLIGHT 100/A-C	Solar Sokak Aydınlatma 100W 4000K	1	FİYAT SORUNUZ
SAVLIGHT 120/A-C	Solar Sokak Aydınlatma 120W 4000K	1	FİYAT SORUNUZ

YOL AYDINLATMA ARMATÜRLERİ

LS021-LS022



CB



ÜRÜN KODU	ÜRÜN ADI	KOLİ AD.	FİYAT
M131203024000	LS022 Sokak Armatürü 60W 3000K	1	402,00 \$
M131204024000	LS022 Sokak Armatürü 60W 4000K	1	402,00 \$
M131206524000	LS022 Sokak Armatürü 60W 6500K	1	402,00 \$
M131003024000	LS022 Sokak Armatürü 80W 3000K	1	418,00 \$
M131004024000	LS022 Sokak Armatürü 80W 4000K	1	418,00 \$
M131006524000	LS022 Sokak Armatürü 80W 6500K	1	418,00 \$
M131503048000	LS021 Sokak Armatürü 130W 3000K	1	631,00 \$
M131504048000	LS021 Sokak Armatürü 130W 4000K	1	631,00 \$
M131506548000	LS021 Sokak Armatürü 130W 6500K	1	631,00 \$
M131513048000	LS021 Sokak Armatürü 150W 3000K	1	646,00 \$
M131514048000	LS021 Sokak Armatürü 150W 4000K	1	646,00 \$
M131516548000	LS021 Sokak Armatürü 150W 6500K	1	646,00 \$

LS021-LS022 60W - 150W

Yol Aydınlatma Armatürleri

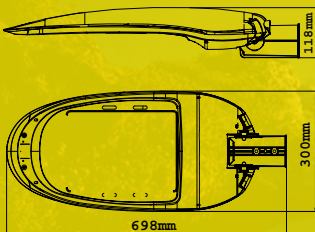

YOL AYDINLATMA ARMATÜRLERİ

ND SOKAK ARMATÜRÜ ECO

ÜRÜN KODU

ÜRÜN ADI

KOLİ AD.

FİYAT



T8005065000

ND Sokak Armatürü Eco 50W 6500K

1

328,00 \$

T8006065000

ND Sokak Armatürü Eco 60W 6500K

1

328,00 \$

T8008065000

ND Sokak Armatürü Eco 80W 6500K

1

328,00 \$



T8010065100

ND Sokak Armatürü Eco 100W 6500K

1

361,00 \$

T8012065100

ND Sokak Armatürü Eco 120W 6500K

1

361,00 \$

T8015065100

ND Sokak Armatürü Eco 140W 6500K

1

361,00 \$

ND ECO 50W - 140W

Yol Aydınlatma Armatürleri

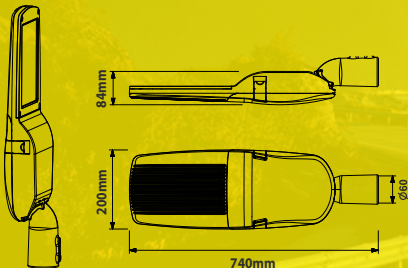

**İŞİK
VARSA
HAYAT
VAR**

SENSÖRLÜ, LEDLİ TAVAN ARMATÜRLERİ

SENSÖRLÜ LEDLİ TAVAN ARMATÜRLERİ

na·De®

RADARLI TAVAN ARMATÜRLERİ

ÜRÜN KODU

ÜRÜN ADI

KOLİ AD.

FİYAT

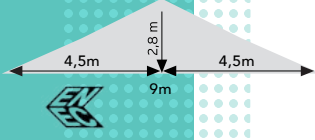

10970.03

Radarlı Ledli Tavan Armatürü 15W 3000K

10

99,00 \$

10970.04

Radarlı Ledli Tavan Armatürü 15W 4000K

10

99,00 \$

10970

Radarlı Ledli Tavan Armatürü 15W 6500K

10

99,00 \$

***Özel Kodlu Ürünlerde ENEC Belgeli Driver Kullanılmaktadır.

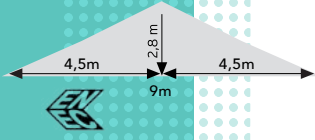

10971.03

Radarlı Acilli Ledli Tavan Armatürü 15W 3000K

10

137,00 \$

10971.04

Radarlı Acilli Ledli Tavan Armatürü 15W 4000K

10

137,00 \$

10971

Radarlı Acilli Ledli Tavan Armatürü 15W 6500K

10

137,00 \$

***Özel Kodlu Ürünlerde ENEC Belgeli Driver Kullanılmaktadır.

YENİ



ND10983.Ö

Tavan ARM. 12W Radarlı 4000K Difüzörlü

14

50,00 \$

ND10984.Ö

Tavan ARM. Acilli 12W Radarlı 4000K Difüzörlü

14

69,00 \$

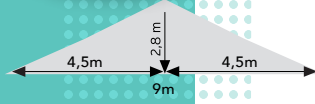

10950

1xE27 Duylu Radarlı Tavan Armatürü

9

56,00 \$

SENSÖRLÜ LEDLİ TAVAN ARMATÜRLERİ

na·De®

RADARLI TAVAN ARMATÜRLERİ

ÜRÜN KODU	ÜRÜN ADI	KOLİ AD.	FİYAT
10951.03	Radarlı Acilli Ledli Tavan Armatürü 20W 3000K	9	84,00 \$
10951.04	Radarlı Acilli Ledli Tavan Armatürü 20W 4000K	9	84,00 \$
10951	Radarlı Acilli Ledli Tavan Armatürü 20W 6500K	9	84,00 \$

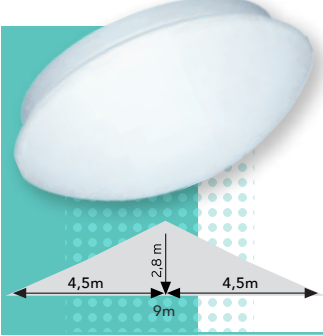

10952.03	Radarlı Ledli Tavan Armatürü 20W 3000K	9	69,00 \$
10952.04	Radarlı Ledli Tavan Armatürü 20W 4000K	9	69,00 \$
10952	Radarlı Ledli Tavan Armatürü 20W 6500K	9	69,00 \$



ND10960	Tavan ARM. Radarlı Çift Porselen Duy Düz Cam	14	34,00 \$
ND10961	Tavan ARM. Radarlı Tek Porselen Duy Düz Cam	14	31,00 \$
ND10962	Tavan ARM. Acilli Radarlı Çift Pors. Duy Düz Cam	14	49,00 \$



ND10963.Ö	Tavan ARM. 12W Radarlı 4000K, PF>0,95 Düz Cam	14	48,00 \$
ND10964.Ö	Tavan ARM. Acilli 12W Radarlı 4000K PF>0,95 Düz Cam	14	58,00 \$

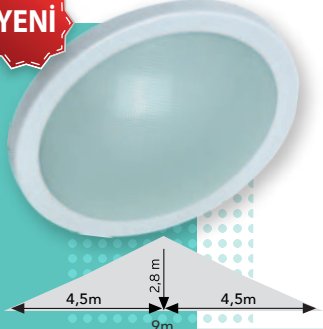

SENSÖR VE SENSÖRLÜ
AYDINLATMA SİSTEMLERİ



DMY Elektrik Otomasyon Aydınlatma San. ve Tic. A.Ş.
www.dmyeo.com.tr



SENSÖRLÜ LEDLİ TAVAN ARMATÜRLERİ

LEDLİ TAVAN ARMATÜRLERİ

ÜRÜN KODU

ÜRÜN ADI

KOLİ AD.

FİYAT



01000.03 KROM

360°HS Ledli Tavan Armatürü 12W 3000K

14

69,00 \$

01000.04 KROM

360°HS Ledli Tavan Armatürü 12W 4000K

14

69,00 \$

01000 KROM

360°HS Ledli Tavan Armatürü 12W 6500K

14

69,00 \$

SENSÖR VE SENSÖRLÜ
AYDINLATMA SİSTEMLERİ



01000.03

360°HS Ledli Tavan Armatürü 12W 3000K

14

57,00 \$

01000.04

360°HS Ledli Tavan Armatürü 12W 4000K

14

57,00 \$

01000

360°HS Ledli Tavan Armatürü 12W 6500K

14

57,00 \$

01000.04-Ö

360°HS Ledli Tavan Armatürü 12W 4000K
PF>0,95

14

62,00 \$

ND1000-12-03

360°HS Ledli Tavan Armatürü 12W 6500K

14

27,00 \$

ND1000.Ö

360°HS Ledli Tavan Armatürü 12W 4000K
PF>0,95

14

41,00 \$

***Özel Kodlu Ürünlerde ENEC Belgeli Driver Kullanılmaktadır.



ND10967.Ö

Tavan ARM. 12W Radarlı 4000K, PF>0,95 Düz Cam

14

48,00 \$

ND10968.Ö

Tavan ARM.Acilli 12W Radarlı 4000K PF>0,95 Düz Cam

14

65,00 \$

SENSÖRLÜ LEDLİ TAVAN ARMATÜRLERİ

na·De®

LEDLİ TAVAN ARMATÜRLERİ

ÜRÜN KODU

ÜRÜN ADI

KOLİ AD.

FİYAT

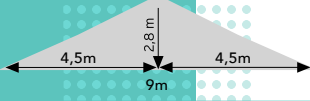

01051.03 KROM

360°HS Acilli Ledli Tavan Armatürü 12W 3000K

14

84,00 \$

01051.04 KROM

360°HS Acilli Ledli Tavan Armatürü 12W 4000K

14

84,00 \$

01051 KROM

360°HS Acilli Ledli Tavan Armatürü 12W 6500K

14

84,00 \$

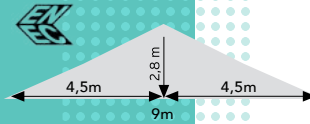

01051.03

360°HS Acilli Ledli Tavan Armatürü 12W 3000K

14

72,00 \$

01051.04

360°HS Acilli Ledli Tavan Armatürü 12W 4000K

14

72,00 \$

01051

360°HS Acilli Ledli Tavan Armatürü 12W 6500K

14

72,00 \$

01051.04.Ö

360°HS Acilli Ledli Tavan Armatürü 12W 4000K
PF>0,95

14

77,00 \$

ND1051-12-03

360°HS Acilli Ledli Tavan Armatürü 12W 6500K

14

37,00 \$

ND1051.Ö

360°HS Acilli Ledli Tavan Armatürü 12W 4000K
PF>0,95

14

51,00 \$

***Özel Kodlu Ürünlerde ENEC Belgeli Driver Kullanılmaktadır.

SENSÖR VE SENSÖRLÜ
AYDINLATMA SİSTEMLERİ



DMY Elektrik Otomasyon Aydınlatma San. ve Tic. A.Ş.
www.dmyeo.com.tr



SENSÖRLÜ LEDLİ TAVAN ARMATÜRLERİ

na·De®

LEDLİ TAVAN ARMATÜRLERİ

ÜRÜN KODU

ÜRÜN ADI

KOLİ AD.

FİYAT



10551.03 KROM

360°HS Ledli Tavan Armatürü 18W 3000K

12

69,00 \$

10551.04 KROM

360°HS Ledli Tavan Armatürü 18W 4000K

12

69,00 \$

10551 KROM

360°HS Ledli Tavan Armatürü 18W 6500K

12

69,00 \$



10551.03

360°HS Ledli Tavan Armatürü 18W 3000K

12

57,00 \$

10551.04

360°HS Ledli Tavan Armatürü 18W 4000K

12

57,00 \$

10551

360°HS Ledli Tavan Armatürü 18W 6500K

12

57,00 \$

10551.04.Ö

360°HS Ledli Tavan Armatürü 18W 4000K
PF>0,95

12

62,00 \$

ND10551-18-03

360°HS Ledli Tavan Armatürü 18W 6500K

12

27,00 \$

ND10551.Ö

360°HS Ledli Tavan Armatürü 18W 4000K
PF>0,95

12

43,00 \$

***Özel Kodlu Ürünlerde ENEC Belgeli Driver Kullanılmaktadır.

SENSÖR VE SENSÖRLÜ
AYDINLATMA SİSTEMLERİ

SENSÖRLÜ LEDLİ TAVAN ARMATÜRLERİ

na·De®

LEDLİ TAVAN ARMATÜRLERİ

ÜRÜN KODU

ÜRÜN ADI

KOLİ AD.

FİYAT



10651.03 KROM

360°HS Acilli Ledli Tavan Armatürü 20W 3000K

12

84,00 \$

10651.04 KROM

360°HS Acilli Ledli Tavan Armatürü 20W 4000K

12

84,00 \$

10651 KROM

360°HS Acilli Ledli Tavan Armatürü 20W 6500K

12

84,00 \$



10651.03

360°HS Acilli Ledli Tavan Armatürü 20W 3000K

12

72,00 \$

10651.04

360°HS Acilli Ledli Tavan Armatürü 20W 4000K

12

72,00 \$

10651

360°HS Acilli Ledli Tavan Armatürü 20W 6500K

12

72,00 \$

10651.04.Ö

360°HS Acilli Ledli Tavan Armatürü 20W 4000K
PF>0,95

12

77,00 \$

ND10651-18-03

360°HS Acilli Ledli Tavan Armatürü 20W 6500K

12

37,00 \$

ND10651.Ö

360°HS Acilli Ledli Tavan Armatürü 20W 4000K
PF>0,95

12

53,00 \$

***Özel Kodlu Ürünlerde ENEC Belgeli Driver Kullanılmaktadır.

SENSÖR VE SENSÖRLÜ
AYDINLATMA SİSTEMLERİ



DMY Elektrik Otomasyon Aydınlatma San. ve Tic. A.Ş.
www.dmyea.com.tr



SENSÖRLÜ DUYLU TAVAN ARMATÜRLERİ

na·De®

DUYLU TAVAN ARMATÜRLERİ

ÜRÜN KODU

ÜRÜN ADI

KOLİ AD.

FİYAT

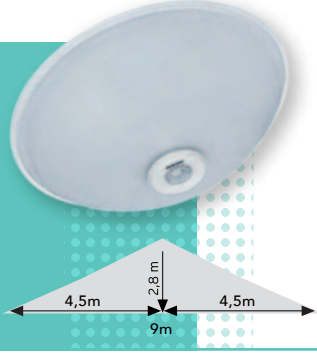

10433.03

360°HS Ledli Tavan Armatürü 20W 3000K

10

65,00 \$

10433.04

360°HS Ledli Tavan Armatürü 20W 4000K

10

65,00 \$

10433

360°HS Ledli Tavan Armatürü 20W 6500K

10

65,00 \$

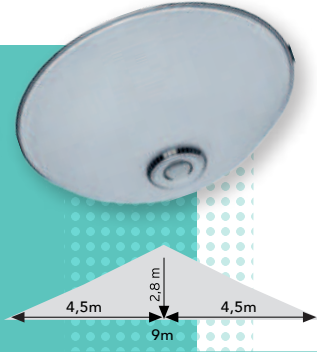

10433.03 KROM

360°HS Ledli Tavan Armatürü 20W 3000K

10

77,00 \$

10433.04 KROM

360°HS Ledli Tavan Armatürü 20W 4000K

10

77,00 \$

10433.06 KROM

360°HS Ledli Tavan Armatürü 20W 6500K

10

77,00 \$



10434.03

360°HS Acilli Ledli Tavan Armatürü 20W 3000K

10

80,00 \$

10434.04

360°HS Acilli Ledli Tavan Armatürü 20W 4000K

10

80,00 \$

10434

360°HS Acilli Ledli Tavan Armatürü 20W 6500K

10

80,00 \$

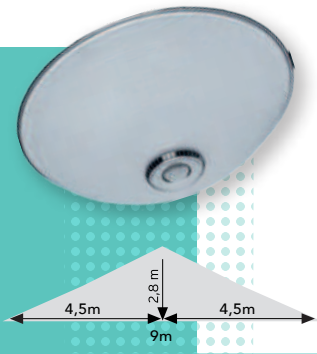

10434.03 KROM

360°HS Acilli Ledli Tavan Armatürü 20W 3000K

10

92,00 \$

10434.04 KROM

360°HS Acilli Ledli Tavan Armatürü 20W 4000K

10

92,00 \$

10434.06 KROM

360°HS Acilli Ledli Tavan Armatürü 20W 6500K

10

92,00 \$

SENSÖR VE SENSÖRLÜ
AYDINLATMA SİSTEMLERİ

SENSÖRLÜ LEDLİ TAVAN ARMATÜRLERİ

na·De®

LEDLİ TAVAN ARMATÜRLERİ

ÜRÜN KODU

ÜRÜN ADI

KOLİ AD.

FİYAT



22999

360°HS Ledli Tavan Armatürü 12W 6500K
Difüzörlü

16

40,00 \$



22999 KROM

360°HS Ledli Tavan Armatürü 12W 6500K
Difüzörlü

16

52,00 \$

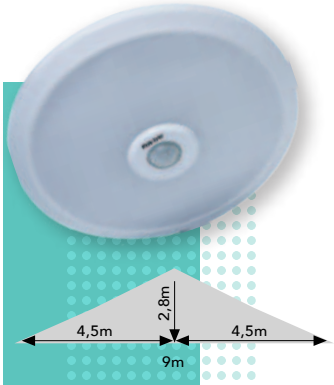

22777

360°HS Acilli Ledli Tavan Armatürü
12W 6500K Difüzörlü

16

52,00 \$



22777 KROM

360°HS Acilli Ledli Tavan Armatürü
12W 6500K Difüzörlü

16

64,00 \$

SENSÖR VE SENSÖRLÜ
AYDINLATMA SİSTEMLERİ



DMY Elektrik Otomasyon Aydınlatma San. ve Tic. A.Ş.
www.dmyea.com.tr



65

SENSÖRLÜ DUYLU TAVAN ARMATÜRLERİ

na·De®

DUYLU TAVAN ARMATÜRLERİ

ÜRÜN KODU

ÜRÜN ADI

KOLİ AD.

FİYAT

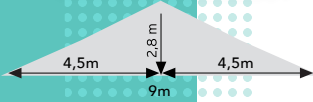

10410.03

360°HS Ledli Tavan Armatürü 6W 3000K

8

104,00 \$

10410.04

360°HS Ledli Tavan Armatürü 6W 4000K

8

104,00 \$

10410

360°HS Ledli Tavan Armatürü 6W 6500K

8

104,00 \$

ND10410

360°HS Ledli Tavan Armatürü 6W 6500K

8

65,00 \$

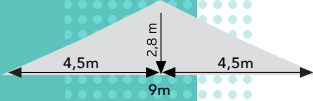

10410.03 GRİ

360°HS, Ledli Tavan Armatürü 6W 3000K

8

109,00 \$

10410.04 GRİ

360°HS Ledli Tavan Armatürü 6W 4000K

8

109,00 \$

10410 GRİ

360°HS Ledli Tavan Armatürü 6W 6500K

8

109,00 \$

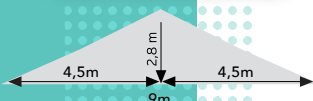

10710.03

360°HS Acilli Ledli Tavan Armatürü 6W 3000K

8

117,00 \$

10710.04

360°HS Acilli Ledli Tavan Armatürü 6W 4000K

8

117,00 \$

10710

360°HS Acilli Ledli Tavan Armatürü 6W 6500K

8

117,00 \$

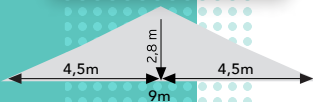

10710.03 GRİ

360°HS Acilli Ledli Tavan Armatürü 6W 3000K

8

122,00 \$

10710.04 GRİ

360°HS Acilli Ledli Tavan Armatürü 6W 4000K

8

122,00 \$

10710 GRİ

360°HS Acilli Ledli Tavan Armatürü 6W 6500K

8

122,00 \$

SENSÖR VE SENSÖRLÜ
AYDINLATMA SİSTEMLERİ

SENSÖRLÜ LEDLİ TAVAN ARMATÜRLERİ

na·De®

LEDLİ DUVAR ARMATÜRLERİ

ÜRÜN KODU

ÜRÜN ADI

KOLİ AD.

FİYAT

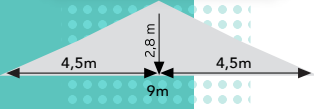

10400

1xE27 Duylu 360°HS Tavan Armatürü

8

62,00 \$

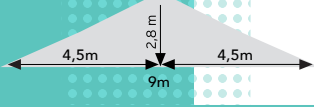

10400 GRİ

1xE27 Duylu 360°HS Tavan Armatürü

8

67,00 \$

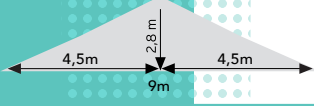

10700

1xE27 Duylu Acilli 360°HS Tavan Armatürü

8

91,00 \$

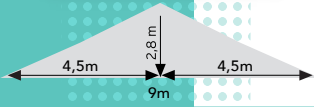

10700 GRİ

1xE27 Duylu Acilli 360°HS Tavan Armatürü

8

96,00 \$

SENSÖR VE SENSÖRLÜ
AYDINLATMA SİSTEMLERİ



DMY Elektrik Otomasyon Aydınlatma San. ve Tic. A.Ş.
www.dmyeo.com.tr



67

SENSÖRLÜ DUYLU TAVAN ARMATÜRLERİ

na·De®

DUYLU DUVAR ARMATÜRLERİ

ÜRÜN KODU

ÜRÜN ADI

KOLİ AD.

FİYAT

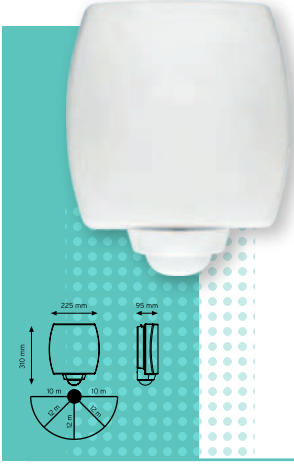

10800

1xE27 Duyulu 180°HS Duvar Armatürü

8

84,00 \$

LEDLİ DUVAR ARMATÜRLERİ



10820.03

180°HS Ledli Duvar Armatürü 8W 3000K

8

87,00 \$

10820.04

180°HS Ledli Duvar Armatürü 8W 4000K

8

87,00 \$

10820

180°HS Ledli Duvar Armatürü 8W 6500K

8

87,00 \$

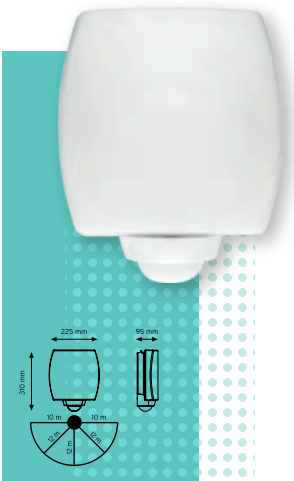

10840.03

180°HS Acilli Ledli Duvar Armatürü 8W 3000K

8

102,00 \$

10840.04

180°HS Acilli Ledli Duvar Armatürü 8W 4000K

8

102,00 \$

10840

180°HS Acilli Ledli Duvar Armatürü, 8W, 6500K

8

102,00 \$

SENSÖRLÜ LEDLİ/DUYLU DUVAR ARMATÜRLERİ

na·De®

LEDLİ / DUYLU DUVAR ARMATÜRLERİ

ÜRÜN KODU

ÜRÜN ADI

KOLİ AD.

FİYAT

10201	1xE27 Duyulu 110°HS Duvar Armatürü	21	50,00 \$
10211.03	110°HS Ledli Duvar Armatürü 12W 3000K	21	62,00 \$
10211.03-3H	110°HS Ledli Duvar Armatürü 12W 3000K A.K	21	78,00 \$
10211.04	110°HS Ledli Duvar Armatürü 12W 4000K	21	62,00 \$
10211.04-3H	110°HS Ledli Duvar Armatürü 12W 4000K A.K	21	78,00 \$
10211	110°HS Ledli Duvar Armatürü 12W 6500K	21	62,00 \$
10211-3H	110°HS Ledli Duvar Armatürü 12W 6500K, A.K	21	78,00 \$

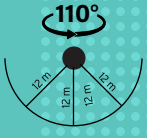

SENSÖR VE SENSÖRLÜ
AYDINLATMA SİSTEMLERİ

YENİ



10203	Duvar Armatürü Radar Porselen Duyulu	10	28,00 \$
10206	Duvar Armatür Radar 12W 6500K Ledli PF>0.95	10	43,00 \$
10206-3H	Duvar Armatürü Radar 12W 6500K Ledli PF>0.95 A.K	10	55,00 \$



Đedal
EVPU

DMY Elektrik Otomasyon Aydınlatma San. ve Tic. A.Ş.
www.dmyeo.com.tr



69

SENSÖRLÜ DUYLU TAVAN ARMATÜRLERİ

na·De®

DUYLU TAVAN ARMATÜRLERİ

ÜRÜN KODU

ÜRÜN ADI

KOLİ AD.

FİYAT

SENSÖR VE SENSÖRLÜ
AYDINLATMA SİSTEMLERİ



00999

2xE27 Duyulu 360°HS Tavan Armatürü

14

35,00 \$

00999 KROM

2xE27 Duyulu 360°HS Tavan Armatürü

14

47,00 \$

ND999-01

2xE27 Duyulu 360°HS Tavan Armatürü, IRC

14

16,00 \$

ND999-03-PD

2xE27 Porselen Duyulu 360°HS Tavan Armatürü

14

18,00 \$



00778

2xE27 Duyulu Acilli 360°HS Tavan Armatürü

14

45,00 \$

ND778-03-PD

2xE27 Porselen Duyulu Acilli
360°HS Tavan Armatürü

14

30,00 \$

00778 KROM

2xE27 Duyulu Acilli 360°HS Tavan Armatürü

14

57,00 \$

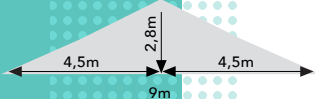

HAREKET SENSÖRLERİ

SENSÖRLÜ LEDLİ TAVAN ARMATÜRLERİ VE VARLIK SENSÖRLERİ

na·De®

VARLIK SENSÖRLERİ

ÜRÜN KODU

ÜRÜN ADI

KOLİ AD.

FİYAT

SENSÖR VE SENSÖRLÜ
AYDINLATMA SİSTEMLERİ

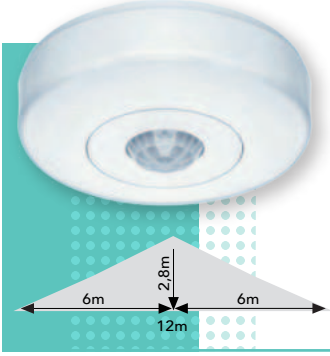

10464

360° Tavan Tipi Hareket Sensörü
Sıva Üstü

72

39,00 \$

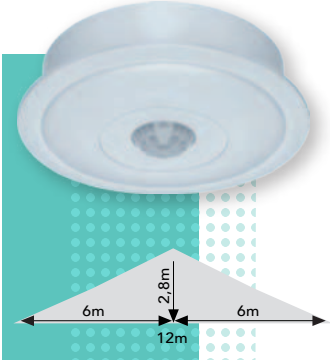

10466

360° Tavan Tipi Hareket Sensörü
Sıva Altı

36

39,00 \$

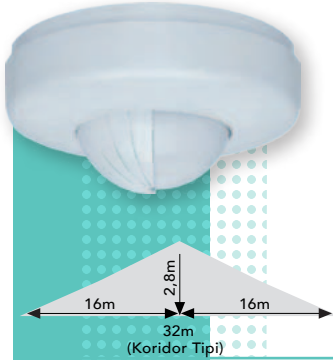

10467

360° Tavan Tipi Hareket Sensörü
Sıva Üstü Koridor

54

49,00 \$

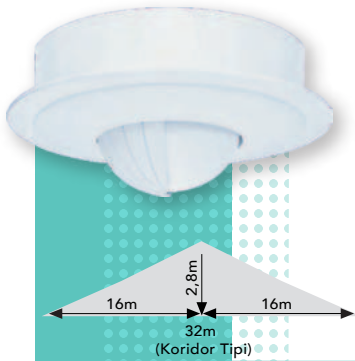

10468

360° Tavan Tipi Hareket Sensörü
Sıva Altı Koridor

42

49,00 \$

SIVA ALTI / SIVA ÜSTÜ HAREKET SENSÖRLERİ

na·De®

TAVAN TİPİ HAREKET SENSÖRLERİ

ÜRÜN KODU

ÜRÜN ADI

KOLİ AD.

FİYAT



10463

360° Tavan Tipi Hareket Sensörü
Siva Üstü

54

52,00 \$

10463-IP

360° Tavan Tipi Hareket Sensörü
Siva Üstü IP54

54

59,00 \$

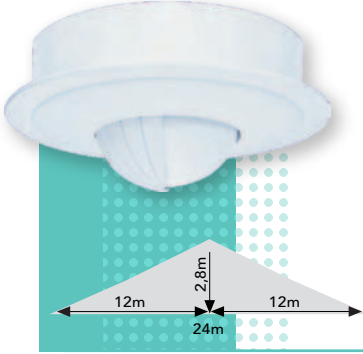

10465

360° Tavan Tipi Hareket Sensörü
Siva Altı

42

52,00 \$

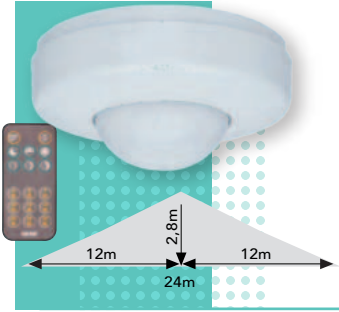

10500

360° Tavan Tipi Varlık Sensörü Siva Üstü

54

57,00 \$

10520

360° Tavan Tipi Varlık Sensörü Siva Üstü
Kumandasız

54

50,00 \$

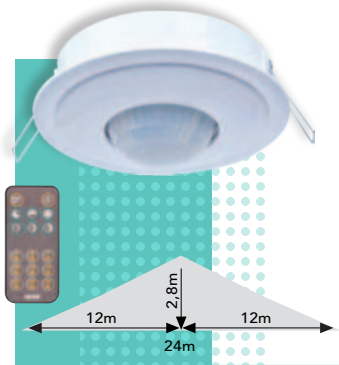

10510

360° Tavan Tipi Varlık Sensörü Siva Altı

42

57,00 \$

10521

360° Tavan Tipi Varlık Sensörü Siva Altı
Kumandasız

42

50,00 \$

SENSÖR VE SENSÖRLÜ
AYDINLATMA SİSTEMLERİ



DMY Elektrik Otomasyon Aydınlatma San. ve Tic. A.Ş.
www.dmyeo.com.tr



73

SIVA ALTI / SIVA ÜSTÜ HAREKET SENSÖRLERİ

na·De®

TAVAN TİPİ HAREKET SENSÖRLERİ

ÜRÜN KODU

ÜRÜN ADI

KOLİ AD.

FİYAT

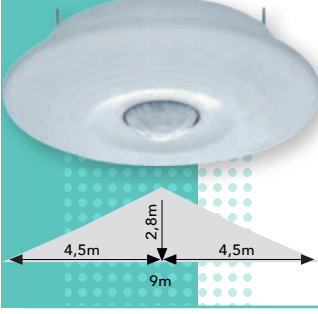

10359

360° Tavan Tipi Hareket Sensörü Siva Altı

24

27,00 \$

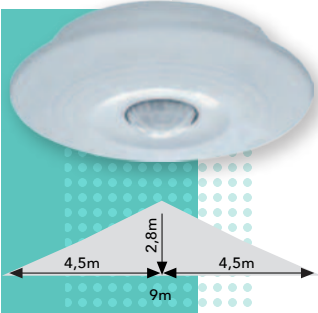

10360

360° Tavan Tipi Hareket Sensörü Siva Üstü

32

27,00 \$



10361

360° Tavan Tipi Hareket Sensörü Siva Üstü

32

35,00 \$



10362

360° Tavan Tipi Hareket Sensörü Siva Altı

32

35,00 \$

SENSÖR VE SENSÖRLÜ
AYDINLATMA SİSTEMLERİ

SIVA ALTI / SIVA ÜSTÜ HAREKET SENSÖRLERİ

na·De®

TAVAN TİPİ HAREKET SENSÖRLERİ

ÜRÜN KODU

ÜRÜN ADI

KOLİ AD.

FİYAT

YENİ

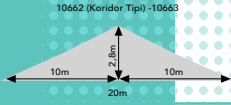
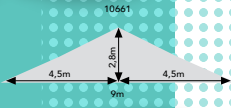

10661-SA

360° Tavan Tipi Hareket Sensörü
Sıva Altı

72

32,00 \$

10662-SA

360° Tavan Tipi Hareket Sensörü Sıva Altı
Koridor

72

38,00 \$

10663-SA

360° Tavan Tipi Hareket Sensörü
Sıva Altı

72

42,00 \$

10661

360° Tavan Tipi Hareket Sensörü
Sıva Altı/ Sıva Üstü

72

32,00 \$

10662

360° Tavan Tipi Hareket Sensörü Sıva Altı/
Sıva Üstü Koridor

72

38,00 \$

10663

360° Tavan Tipi Hareket Sensörü
Sıva Altı/ Sıva Üstü

72

42,00 \$

SENSÖR VE SENSÖRLÜ
AYDINLATMA SİSTEMLERİ

TAVAN TİPİ RADAR SENSÖRLERİ

10366

Tavan Tipi Radar Sensörü Sıva Altı

60

27,00 \$

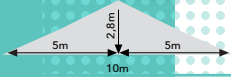

10367

Tavan Tipi Radar Sensörü Sıva Üstü

112

27,00 \$

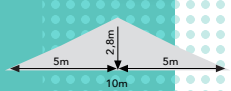

DMY Elektrik Otomasyon Aydınlatma San. ve Tic. A.Ş.
www.dmyeo.com.tr



75

SIVA ALTI / SIVA ÜSTÜ HAREKET VE RADAR SENSÖRLERİ

SPOT TİPİ HAREKET SENSÖRLERİ

ÜRÜN KODU

ÜRÜN ADI

KOLİ AD.

FİYAT



10365

360° Spot Tipi Hareket Sensörü Sıva Altı

40

33,00 \$



10100

Anahtar Tipi Hareket Sensörü

48

30,00 \$



10100 GRİ

Anahtar Tipi Hareket Sensörü

48

35,00 \$

DUVAR SWITCH TİPİ SENSÖRLERİ

DUVAR TİPİ HAREKET SENSÖRLERİ



10180.

180° Duvar Tipi Hareket Sensörü

36

15,00 \$

na·De®

GÖRÜNTÜLÜ VE SESLİ İTERKOM SİSTEMLERİ



GÖRÜNTÜLÜ VE SESLİ
İTERKOM SİSTEMLERİ

LINUX IP İTERKOM SİSTEMLERİ

LINUX IP İTERKOM SİSTEMİ ÖZELLİKLERİ

- Yeni wifi chip entegrasyonu ile daha fazla uygulama desteği
- Sınırsız sayıda daire, kat ve site birimini bağlama
- Bireysel ağ desteklemesi
- Villa ve apartman uygulamalarına uygun kablosuz bağlantı
- Kablolu ve kablosuz hibrid haberleşme
- Yenilenen cep telefonu uygulamasıyla arama yönlendirme, kapı açma, kameraları izleme
- Yüksek çözünürlük, geniş görüntüleme açısı, yüksek kontrastlı gelişmiş ekran ile daha iyi deneyim
- Sektördeki yaygın IP kameralar için ONVIF desteği
- Monitör modunda ekranda aynı anda dört ekran gösterebilme
- Arama modunda zil paneli ve IP kamerayı aynı anda izleyebilme
- 4 zonlu alarm özelliği (ekrana alarm bilgisi verir)
- SD kart ekleme
- Ahize eklenebilme
- Paralel monitör bağlanabilme
- Asansör kontrol fonksiyonu
- Çoklu dil desteği
- Daire önü zile bağlantı
- Şifre veya RF-ID kart ile kapıyı açma
- Siyah, Beyaz renk seçenekleri
- Çevrimiçi yazılım güncellemesi

ND 482SE



Wi-Fi ND 470 S



Wi-Fi ND 471S



GÖRÜNTÜLÜ İNTERKOM SİSTEMLERİ

na·De®

LINUX IP İNTERKOM SİSTEMLERİ

ÜRÜN KODU	ÜRÜN ADI	KOLİ AD.	FİYAT
 IP Wi-Fi	ND 471S 7" Renkli Görüntülü Diafon		242,00 \$
 IP Wi-Fi	ND 470 7" Renkli Görüntülü Diafon Ön Paneli Camlı Çevirilebilir Ekran		254,00 \$
 IP Wi-Fi	ND 470 S 7" Renkli Görüntülü Diafon, Ön Paneli Camlı, Çevirilebilir Ekran, Siyah		254,00 \$
 IP	ND 482SE S 7" Renkli Görüntülü Diafon, Eko Seri		190,00 \$
 IP	GU 471 Güvenlik Telefonu		410,00 \$
 IP	ND 610 Tek Zil Paneli		367,00 \$

GÖRÜNTÜLÜ VE SESLİ İNTERKOM SİSTEMLERİ









DMY Elektrik Otomasyon Aydınlatma San. ve Tic. A.Ş.
www.dmyeo.com.tr



GÖRÜNTÜLÜ İNTERKOM SİSTEMLERİ

na·De®

LINUX IP İNTERKOM SİSTEMLERİ

	ÜRÜN KODU	ÜRÜN ADI	KOLİ AD.	FİYAT
 IP	ND 850	5' Dokunmatik Ekran Zil Paneli		693,00 \$
 IP	ND 821	Modüler Zil Paneli		675,00 \$
 IP	X5 TECH CM0420	4*10/100MPOE+2*100 MBPS UPLINK		69,00 \$
 IP	X5 TECH CM0820	8*10/100MPOE+2*100 MBPS UPLINK		96,00 \$
 IP	X5 TECH CM0820G	8*10/100MPOE+2*1000 MBPS UPLINK		122,00 \$
 IP	ND-LIFT	Asansör Kontrol Modülü (14 Röle)		192,00 \$
	ND-RLC	Röle Kontrol Modülü		192,00 \$

GÖRÜNTÜLÜ İTERKOM SİSTEMLERİ

na·De®

PAKET FİYAT TABLOSU



DAİRE SAYISI	IP İTERKOM		
	7" MONİTÖR	7" MONİTÖR	7" MONİTÖR
	ND 471S.	ND 482SE S.	ND 470. & ND 470 S.
	ZİL PANELİ	ZİL PANELİ	ZİL PANELİ
	ND 850.	ND 850.	ND 850.
1	1.004,00 \$	952,00 \$	1016,00 \$
2	1.246,00 \$	1.142,00 \$	1.270,00 \$
3	1.488,00 \$	1.332,00 \$	1.524,00 \$
4	1.757,00 \$	1.549,00 \$	1.805,00 \$
5	1.999,00 \$	1.739,00 \$	2.059,00 \$
6	2.241,00 \$	1.929,00 \$	2.313,00 \$
7	2.483,00 \$	2.119,00 \$	2.567,00 \$
8	2.794,00 \$	2.378,00 \$	2.890,00 \$
9	3.036,00 \$	2.568,00 \$	3.144,00 \$
10	3.278,00 \$	2.758,00 \$	3.398,00 \$
11	3.520,00 \$	2.948,00 \$	3.652,00 \$
12	3.789,00 \$	3.165,00 \$	3.933,00 \$
13	4.031,00 \$	3.355,00 \$	4.187,00 \$
14	4.273,00 \$	3.545,00 \$	4.441,00 \$
15	4.515,00 \$	3.735,00 \$	4.695,00 \$
16	4.826,00 \$	3.994,00 \$	5.018,00 \$
17	5.068,00 \$	4.184,00 \$	5.272,00 \$
18	5.337,00 \$	4.401,00 \$	5.553,00 \$
19	5.579,00 \$	4.591,00 \$	5.807,00 \$
20	5.821,00 \$	4.781,00 \$	6.061,00 \$
21	6.132,00 \$	5.040,00 \$	6.384,00 \$
22	6.374,00 \$	5.230,00 \$	6.638,00 \$
23	6.616,00 \$	5.420,00 \$	6.892,00 \$
24	6.858,00 \$	5.610,00 \$	7.146,00 \$
25	7.127,00 \$	5.827,00 \$	7.427,00 \$

Tablodaki fiyatlara tesisat ek ürünleri eklenmemiş olup, fiyatlar; monitör, zil paneli, Poe Switch olarak hazırlanmıştır.

IP İTERKOM EK CİHAZLAR

ASANSÖR KONTROL MODÜLÜ FARKI 453,00\$

GÜVENLİK MONİTÖRÜ FARKI 479,00\$

GÖRÜNTÜLÜ VE SESLİ
İTERKOM SİSTEMLERİ



DMY Elektrik Otomasyon Aydınlatma San. ve Tic. A.Ş.
www.dmyeo.com.tr



GÖRÜNTÜLÜ İTERKOM SİSTEMLERİ

na·De®

VİLLA TİPİ BAĞLANTI PRENSİP ŞEMASI



Wi-Fi monitör, bir ev yönlendiricisi kullanıldığında kapı istasyonuyla kablosuz LAN ağ bağlantısını destekler.

TEK BİNA TİPİ BAĞLANTI PRENSİP ŞEMASI

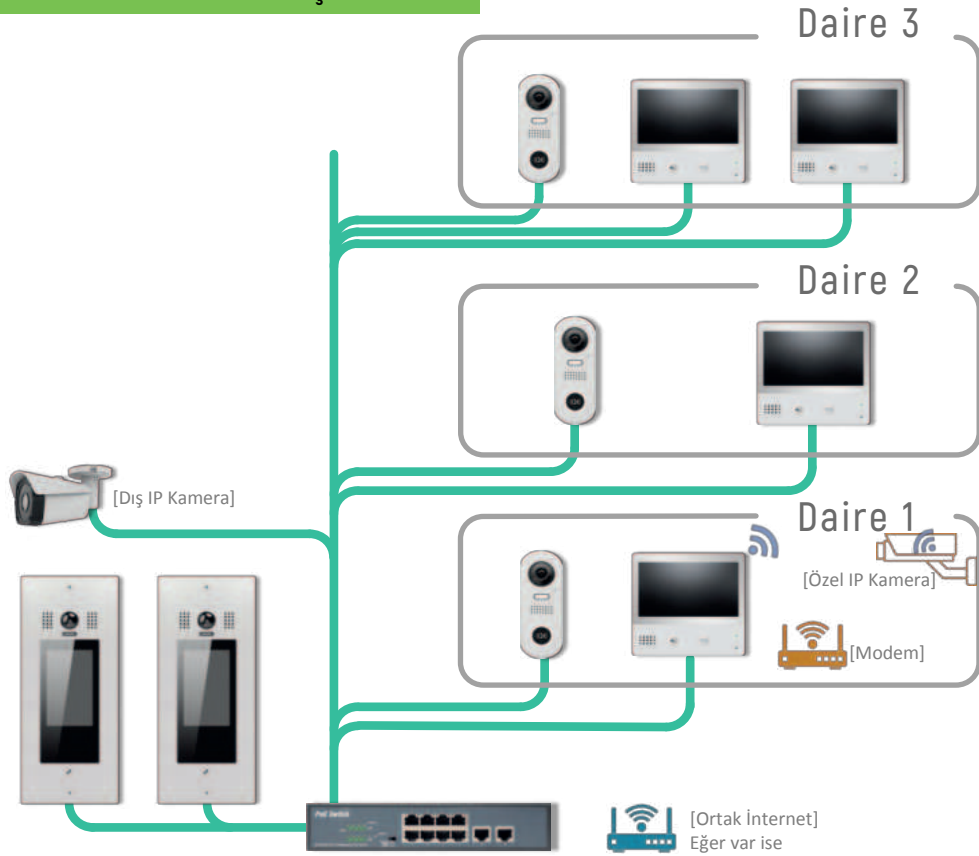

Farklı girişler için çoklu kapı istasyonu, ek güvenlik kameraları ile farklı bir açıdan kapı kontrolü.

GÖRÜNTÜLÜ İNTERKOM SİSTEMLERİ

na·De®

ÇOKLU BİNA TİPİ BAĞLANTI PRENSİP ŞEMASI

İki kapı paylaşımlı çoklu binalarda, güvenlik birimi IP kamera görüntüsü ile her daireyi arayabilir.

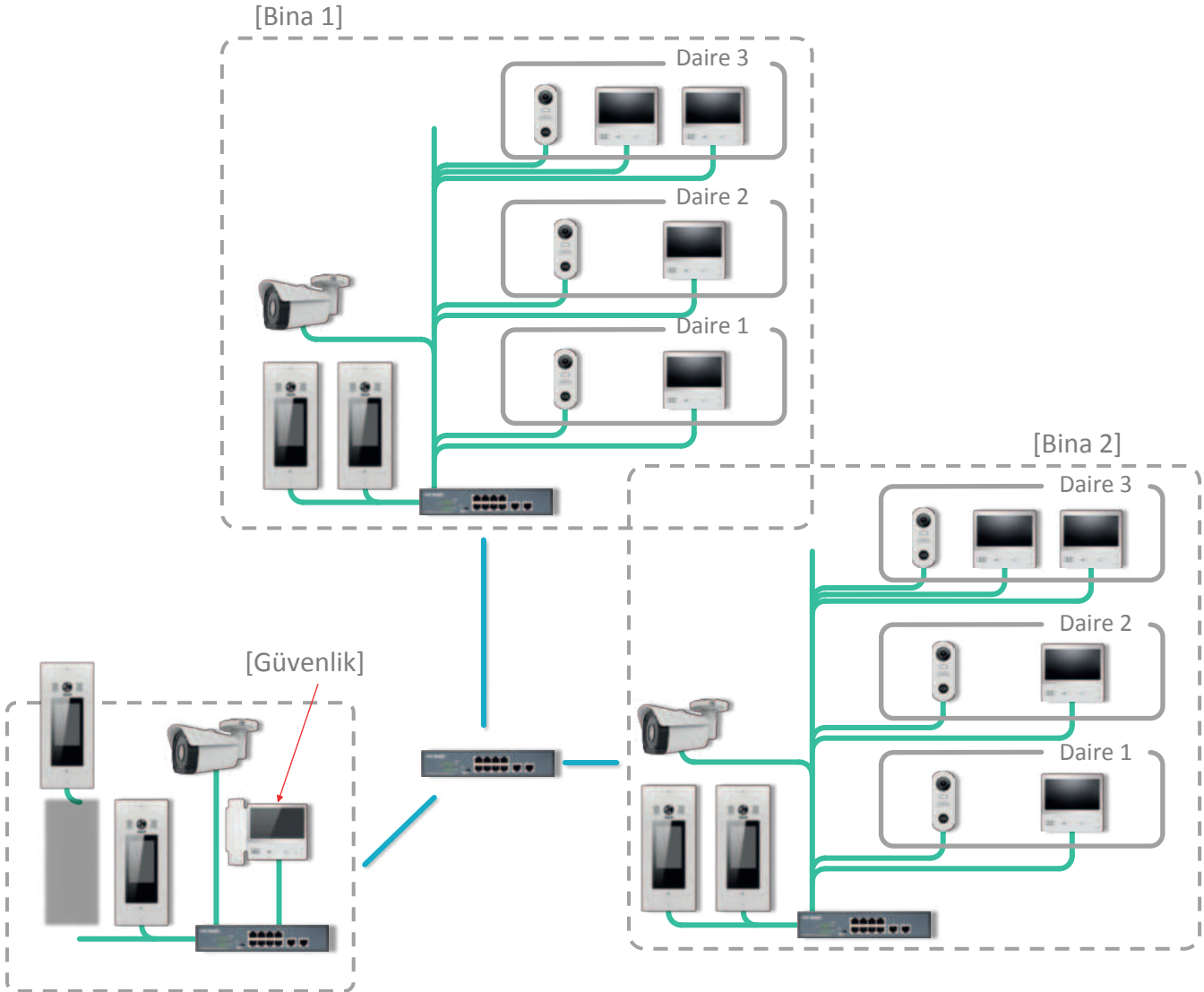

GÖRÜNTÜLÜ VE SESLİ
İNTERKOM SİSTEMLERİ

GÖRÜNTÜLÜ İNTERKOM SİSTEMLERİ

V8 GÖRÜNTÜLÜ İNTERKOM SİSTEMLERİ

V8 Görüntülü İnterkom Sistemleri

- DT-8 kablolarına uygun
- 7" ve 4,3" monitör seçenekleri
- Kapı, güvenlik ve daireler arası görüşme
- Bir daireye maximum 2 adet monitör bağlanabilir
- Dijital zil panelinden güvenlik konsolunun aranabilmesi
- Dijital zil panelinde şifreli veya proximity kart (RF-ID) ile dış kapı açma özelliği
- Besleme: DC 36V

Monitörlerde

- Kapı otomatik açma tuşu
- Zil paneli, kapı önü kamerası ve CCTV görüntüleme tuşu
- Güvenlik/Kapıcı hızlı arama tuşu
- Herkesin kullanabileceği basit arayüz
- Apartman kapı zili ve daire zillerinin ayırt edilebilmesi
- OSD menü
- Zil sesi seviye ayarı
- Rahatsız etmeyin özelliği
- Ekran renk ve kontrast ayarı
- 1 adet ilave monitör bağlanabilir
- Uzun süre sorunsuz çalışma
- Kolay montaj ve kablo bağlantısı

Kameralı dijital zil panellerinde

- Grafik LCD ekran
- Fonksiyonel ve LED aydınlatmalı dayanıklı tuş takımı
- Herkesin kullanabileceği basit arayüz
- Kamera gece görüşü için yüksek parlaklıkta aydınlatma LED'leri
- Servis menüsü desteği

Güvenlik telefonlarında



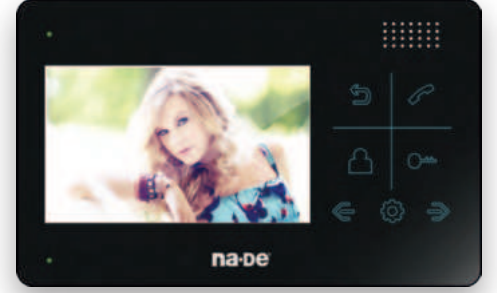

- Grafik LCD ekran
- Multi medya oynatıcı
- DVR özelliği
- Rehber fonksiyonu ile istenilen isimle hızlı erişim ve arama
- Dokunmatik ekran
- Çağrı geçmişi
- Arayan dairenin, blok numarası, daire numarası ve arayan isminin ekranda görüntülenmesi
- Tarih-Saat fonksiyonu

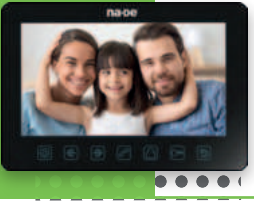

GÖRÜNTÜLÜ İNTERKOM SİSTEMLERİ

na·De®

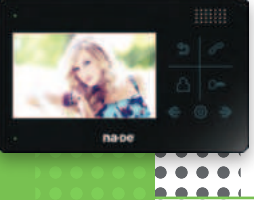
V8 GÖRÜNTÜLÜ İNTERKOM SİSTEMLERİ

ÜRÜN KODU	ÜRÜN ADI	KOLİ AD.	FİYAT
 V8	M2307ADT-8 7" Renkli Görüntülü Diafon - Beyaz	25	178,00 \$
 V8	M2307ADT-8 S 7" Renkli Görüntülü Diafon - Siyah	25	178,00 \$
 V8	M2804ADT-8 4,3" Renkli Görüntülü Diafon - Beyaz	25	111,00 \$
 V8	M2804ADT-8 S 4,3" Renkli Görüntülü Diafon - Siyah	25	111,00 \$
 V8	M2604ADT-8 4,3" Renkli Görüntülü Diafon - Beyaz	25	108,00 \$
 V8	D28AC Dijital Kameralı Zil Panelleri - Gümüş	5	393,00 \$

GÖRÜNTÜLÜ VE SESLİ
İNTERKOM SİSTEMLERİ



DMY Elektrik Otomasyon Aydınlatma San. ve Tic. A.Ş.
www.dmyeo.com.tr



85

GÖRÜNTÜLÜ İNTERKOM SİSTEMLERİ

na·De®

V8 GÖRÜNTÜLÜ İNTERKOM SİSTEMLERİ

ÜRÜN KODU	ÜRÜN ADI	KOLİ AD.	FİYAT
 V8	D28AC S Dijital Kameralı Zil Panelleri - Siyah	5	393,00 \$
 V8	D28BC Dijital Kameralı RF-ID Kartlı Zil Panel-Gümüş	5	436,00 \$
 V8	D28BC S Dijital Kameralı RF-ID Kartlı Zil Panel-Siyah	5	436,00 \$
 V8	M1607BCR Güvenlik Telefonu	-	346,00 \$
 V8	NV03 Dağıtıcı	24	122,00 \$
 V8	PW01.1 Güç Kaynağı	50	89,00 \$

GÖRÜNTÜLÜ VE SESLİ
İNTERKOM SİSTEMLERİ

GÖRÜNTÜLÜ İTERKOM SİSTEMLERİ

na·De®

PAKET FİYAT TABLOSU

V8		
	4,3" MONİTÖR	4,3" MONİTÖR
	M2804ADT-8.	M2804ADT-8.
	ZİL PANELİ	ZİL PANELİ
	D28AC.	D28BC.(KARTLI GEÇİŞ)
DAİRE SAYISI		
1	715,00 \$	758,00 \$
2	826,00 \$	869,00 \$
3	937,00 \$	980,00 \$
4	1.048,00 \$	1.091,00 \$
5	1.159,00 \$	1.202,00 \$
6	1.270,00 \$	1.313,00 \$
7	1.381,00 \$	1.424,00 \$
8	1.492,00 \$	1.535,00 \$
9	1.603,00 \$	1.646,00 \$
10	1.714,00 \$	1.757,00 \$
11	1.825,00 \$	1.868,00 \$
12	1.936,00 \$	1.979,00 \$
13	2.047,00 \$	2.090,00 \$
14	2.158,00 \$	2.201,00 \$
15	2.269,00 \$	2.312,00 \$
16	2.380,00 \$	2.423,00 \$
17	2.491,00 \$	2.534,00 \$
18	2.602,00 \$	2.645,00 \$
19	2.713,00 \$	2.756,00 \$
20	2.824,00 \$	2.867,00 \$
21	3.024,00 \$	3.067,00 \$
22	3.135,00 \$	3.178,00 \$
23	3.246,00 \$	3.289,00 \$
24	3.357,00 \$	3.400,00 \$
25	3.468,00 \$	3.511,00 \$

Tablodaki fiyatlara tesisat ek ürünleri eklenmemiş olup, fiyatlar; monitör, zil paneli, dağıtıcı ve güç kaynağı olarak hazırlanmıştır.

V8 EK CİHAZLAR

KAPICI FARKI 111,00\$

GÜVENLİK MONİTÖRÜ FARKI 548,00\$

GÖRÜNTÜLÜ VE SESLİ
İTERKOM SİSTEMLERİ

GÖRÜNTÜLÜ İTERKOM SİSTEMLERİ

na·De®

PAKET FİYAT TABLOSU

DAİRE SAYISI	V8	
	7" MONİTÖR	7" MONİTÖR
	M2307ADT-8.	M2307ADT-8.
	ZİL PANELİ	ZİL PANELİ
	D28AC	D28BC.(KARTLI GEÇİŞ)
1	782,00 \$	825,00 \$
2	960,00 \$	1.003,00 \$
3	1.138,00 \$	1.181,00 \$
4	1.316,00 \$	1.359,00 \$
5	1.494,00 \$	1.537,00 \$
6	1.672,00 \$	1.715,00 \$
7	1.850,00 \$	1.893,00 \$
8	2.028,00 \$	2.071,00 \$
9	2.206,00 \$	2.249,00 \$
10	2.384,00 \$	2.427,00 \$
11	2.562,00 \$	2.605,00 \$
12	2.740,00 \$	2.783,00 \$
13	2.918,00 \$	2.961,00 \$
14	3.096,00 \$	3.139,00 \$
15	3.274,00 \$	3.317,00 \$
16	3.452,00 \$	3.495,00 \$
17	3.630,00 \$	3.673,00 \$
18	3.808,00 \$	3.851,00 \$
19	3.986,00 \$	4.029,00 \$
20	4.164,00 \$	4.207,00 \$
21	4.431,00 \$	4.474,00 \$
22	4.609,00 \$	4.652,00 \$
23	4.787,00 \$	4.830,00 \$
24	4.965,00 \$	5.008,00 \$
25	5.143,00 \$	5.186,00 \$

Tablodaki fiyatlara tesisat ek ürünleri eklenmemiş olup, fiyatlar; monitör, zil paneli, dağıtıcı ve güç kaynağı olarak hazırlanmıştır.

V8 EK CİHAZLAR

KAPICI FARKI 178,00\$

GÜVENLİK MONİTÖRÜ FARKI 548,00\$

GÖRÜNTÜLÜ İNTERKOM SİSTEMLERİ

na·De®

V8 SİSTEMİ BAĞLANTI ŞEMASI

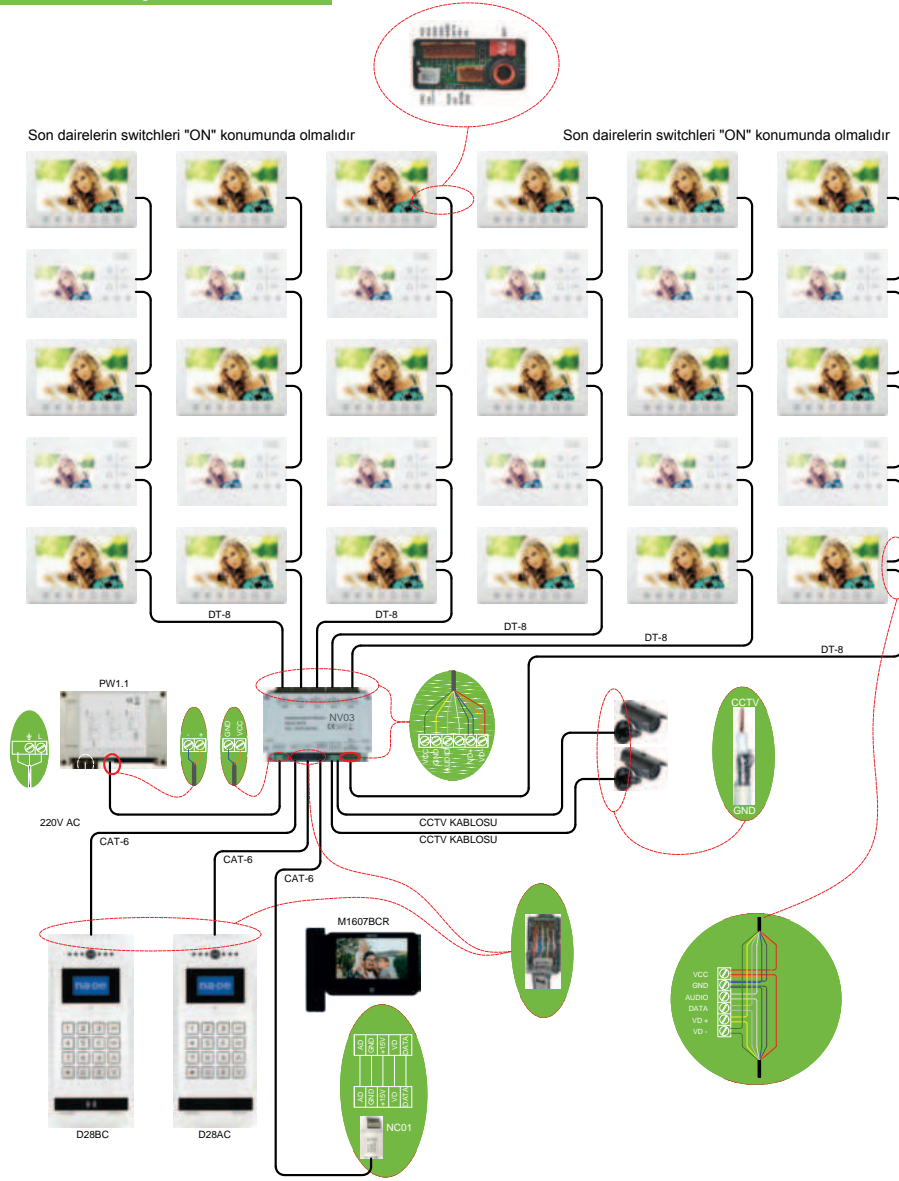

**** V8 sistemlerinde ek tesisat ürünleri aşağıdaki açıklamalara göre verilmelidir.**

V8 sistemin kablolama alt yapısı daireden daireye olması önerilir. Eğer şaftlı sistem kullanılacak ise 1 kolon hattına maksimum 12 daire bağlanmalıdır..

Kapıcı telefonu tercihe göre farklılık gösterebilir (M2307ADT-8 - M2804ADT-8).

M1607BCR güvenlik telefonu ile dağıtıcı arasındaki mesafe en fazla 100 m olmalıdır.

Güvenlik telefonunda kullanılacak kablo CAT6 olmalıdır.

Güvenlik telefonu ilave edildiğinde RJ-45 bağlantı soketi kullanılmadık.

Blok sayısı arttıkça bu oranda NH01 yatay dağıtıcı kullanılmalıdır.

PW01.1 Güç Kaynağı Farkı

- Güç kaynağı kapasitesi aşağıdaki tabloda verilmiştir.
- Kapasite aşıldığı durumda PW01.1 ürünü ilave olarak verilmelidir.

KABLO ÇEŞİDİ

DT8 - CAT6

MAX MONİTÖR

20 Monitör

GÖRÜNTÜLÜ VE SESLİ
İNTERKOM SİSTEMLERİ



Dedal
EVPU

DMY Elektrik Otomasyon Aydınlatma San. ve Tic. A.Ş.
www.dmyeo.com.tr

DMY
ELEKTRİK OTOMASYON AYDINLATMA

GÖRÜNTÜLÜ İNTERKOM SİSTEMLERİ

na·De®

V-BUS9 GÖRÜNTÜLÜ İNTERKOM SİSTEMLERİ

V-BUS9 Görüntülü İnterkom Sistemleri

- CAT6 kablolarına uygun
- Yüksek katlarda ve şaftlı sistemlerde kullanıma uygun
- 7" ve 4,3" monitör seçenekleri
- 3 farklı zil sesi; Apartman kapısı zili, daire kapısı zili, oda zili melodisi
- Dijital zil panelinden güvenlik konsolunun aranabilmesi
- Dijital zil panelinde şifreli dış kapı açma ve proximity kart (RF-ID) ile dış kapı açma özelliği
- Besleme: DC 36V

Monitörlerde

- Kapı otomatığı açma tuşu
- Zil paneli görüntüleme tuşu, apartmana bağlı zil panellerinin kameralarını görüntülemek için
- Güvenlik/Kapıcı hızlı arama tuşu
- Herkesin kullanabileceği basit arayüz
- Daire kapılarının önüne kameralı zil butonu veya harici kamera bağlanıp, zile basıldığında veya istenildiğinde izlenebilmesi
- Sosyal tesisleri arayabilme
- Apartman kapı zili, daire zili ve odadan arama zillerini ayırt edilebilmesi
- OSD menü
- Zil sesi seviye ayarı
- Ekran renk ve kontrast ayarı
- Bir daireye max. 4 adet monitör bağlanabilmesi
- Uzun süre sorunsuz çalışma
- Kolay montaj ve kablo bağlantısı
- Resim çekme özelliği
- Daireler arası görüşme
- Odalar arası görüşme
- Rahatsız edilmeme özelliği
- Oda dinleme: Çocuk odaları dinlenebilir

Kameralı dijital zil panellerinde

- Grafik LCD ekran
- Fonksiyonel ve LED aydınlatmalı dayanıklı tuş takımı
- Herkesin kullanabileceği basit arayüz
- Kamera gece görüşü için yüksek parlaklıkta aydınlatma LED'leri
- Servis menüsü desteği

Güvenlik telefonlarında



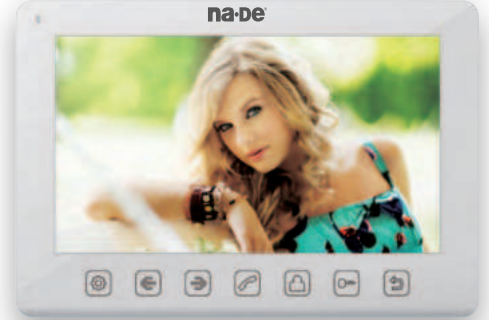

- Grafik LCD ekran
- Multi medya oynatıcı
- DVR özelliği
- Rehber fonksiyonu ile istenilen isime hızlı erişim ve arama
- Dokunmatik ekran
- Çağrı geçmişi
- Arayan dairenin, blok numarası, daire numarası ve arayan isminin ekranda görüntülenmesi
- Tarih-Saat fonksiyonu

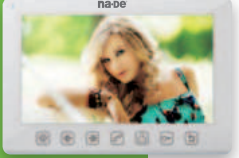

GÖRÜNTÜLÜ İNTERKOM SİSTEMLERİ

na·De®

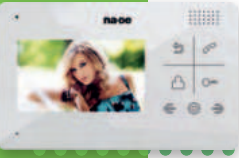
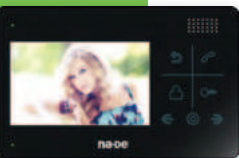
V-BUS9 GÖRÜNTÜLÜ İNTERKOM SİSTEMLERİ

ÜRÜN KODU	ÜRÜN ADI	KOLİ AD.	FİYAT
 V-BUS9	M2307ADT 7" Renkli Görüntülü Diafon - Beyaz	24	178,00 \$
 V-BUS9	M2307ADT S 7" Renkli Görüntülü Diafon - Siyah	24	178,00 \$
 V-BUS9	M2804ADT 4,3" Renkli Görüntülü Diafon - Beyaz	25	111,00 \$
 V-BUS9	M2804ADT S 4,3" Renkli Görüntülü Diafon - Siyah	25	111,00 \$
 V-BUS9	D28AC Dijital Kameralı Zil Panelleri - Gümüş	5	393,00 \$
 V-BUS9	D28AC S Dijital Kameralı Zil Panelleri - Siyah	5	393,00 \$

GÖRÜNTÜLÜ VE SESLİ
İNTERKOM SİSTEMLERİ



DMY Elektrik Otomasyon Aydınlatma San. ve Tic. A.Ş.
www.dmyeo.com.tr



91

GÖRÜNTÜLÜ İNTERKOM SİSTEMLERİ

na·De®







V-BUS9 GÖRÜNTÜLÜ İNTERKOM SİSTEMLERİ

	ÜRÜN KODU	ÜRÜN ADI	KOLİ AD.	FİYAT
 V-BUS9	D28BC	Dijital Kameralı RF-ID Kartlı Zil Panel-Gümüş	5	436,00 \$
 V-BUS9	D28BC S	Dijital Kameralı RF-ID Kartlı Zil Panel-Siyah	5	436,00 \$
 V-BUS9	M1607BCR	Güvenlik Telefonu	-	346,00 \$
 V-BUS9	NH01	Yatay Dağıtıcı	36	190,00 \$
 V-BUS9	NH02	Yatay Dağıtıcı	36	190,00 \$
 V-BUS9	NH03	Yatay Dağıtıcı	36	203,00 \$

GÖRÜNTÜLÜ İNTERKOM SİSTEMLERİ

na·De®

V-BUS9 GÖRÜNTÜLÜ İNTERKOM SİSTEMLERİ

ÜRÜN KODU	ÜRÜN ADI	KOLİ AD.	FİYAT
 V-BUS9	NV01 Dikey Dağıtıcı (4 Çıkışlı)	36	97,00 \$
	NV06 Dikey Dağıtıcı (8 Çıkışlı)	36	115,00 \$
 V-BUS9	NV04 Sinyal Güçlendirici	36	202,00 \$
 V-BUS9	NC01 RJ45 Bağlantı Soketi	244	12,00 \$
 V-BUS9	PW01.1 Güç Kaynağı	50	89,00 \$
	RF-ID KEY-8 RF-ID Anahtar	1	1,50 \$
	RF-ID CARD-8 RF-ID Kart	1	1,50 \$

GÖRÜNTÜLÜ VE SESLİ
İNTERKOM SİSTEMLERİ



DMY Elektrik Otomasyon Aydınlatma San. ve Tic. A.Ş.
www.dmyeo.com.tr



GÖRÜNTÜLÜ İNTERKOM SİSTEMLERİ

na·De®

PAKET FİYAT TABLOSU

DAİRE SAYISI	V-BUS9	
	4,3" MONİTÖR	4,3" MONİTÖR
	M2804ADT.	M2804ADT.
	ZİL PANELİ	ZİL PANELİ
	D28AC.	D28BC.(KARTLI GEÇİŞ)
1	702,00 \$	745,00 \$
2	825,00 \$	868,00 \$
3	948,00 \$	991,00 \$
4	1.168,00 \$	1.211,00 \$
5	1.291,00 \$	1.334,00 \$
6	1.414,00 \$	1.457,00 \$
7	1.537,00 \$	1.580,00 \$
8	1.757,00 \$	1.800,00 \$
9	1.880,00 \$	1.923,00 \$
10	2.003,00 \$	2.046,00 \$
11	2.126,00 \$	2.169,00 \$
12	2.346,00 \$	2.389,00 \$
13	2.469,00 \$	2.512,00 \$
14	2.592,00 \$	2.635,00 \$
15	2.715,00 \$	2.758,00 \$
16	2.935,00 \$	2.978,00 \$
17	3.058,00 \$	3.101,00 \$
18	3.181,00 \$	3.224,00 \$
19	3.304,00 \$	3.347,00 \$
20	3.524,00 \$	3.567,00 \$
21	3.736,00 \$	3.779,00 \$
22	3.859,00 \$	3.902,00 \$
23	3.982,00 \$	4.025,00 \$
24	4.202,00 \$	4.245,00 \$
25	4.325,00 \$	4.368,00 \$

Tablodaki fiyatlara tesisat ek ürünleri eklenmemiş olup, fiyatlar; monitör, zil paneli, dağıtıcı ve güç kaynağı olarak hazırlanmıştır.

V-BUS 9 EK CİHAZLAR

KAPICI FARKI 123,00\$

GÜVENLİK MONİTÖRÜ FARKI 548,00\$

GÖRÜNTÜLÜ İNTERKOM SİSTEMLERİ

na·De®

PAKET FİYAT TABLOSU

DAİRE SAYISI	V-BUS9	
	7" MONİTÖR	7" MONİTÖR
	M2307ADT.	M2307ADT.
	ZİL PANELİ	ZİL PANELİ
	D28AC.	D28BC.(KARTLI GEÇİŞ)
1	769,00 \$	812,00 \$
2	959,00 \$	1.002,00 \$
3	1.149,00 \$	1.192,00 \$
4	1.436,00 \$	1.479,00 \$
5	1.626,00 \$	1.669,00 \$
6	1.816,00 \$	1.859,00 \$
7	2.006,00 \$	2.049,00 \$
8	2.293,00 \$	2.336,00 \$
9	2.483,00 \$	2.526,00 \$
10	2.673,00 \$	2.716,00 \$
11	2.863,00 \$	2.906,00 \$
12	3.150,00 \$	3.193,00 \$
13	3.340,00 \$	3.383,00 \$
14	3.530,00 \$	3.573,00 \$
15	3.720,00 \$	3.763,00 \$
16	4.007,00 \$	4.050,00 \$
17	4.197,00 \$	4.240,00 \$
18	4.387,00 \$	4.430,00 \$
19	4.577,00 \$	4.620,00 \$
20	4.864,00 \$	4.907,00 \$
21	5.143,00 \$	5.186,00 \$
22	5.333,00 \$	5.376,00 \$
23	5.523,00 \$	5.566,00 \$
24	5.810,00 \$	5.853,00 \$
25	6.000,00 \$	6.043,00 \$

Tablodaki fiyatlara tesisat ek ürünleri eklenmemiş olup, fiyatlar; monitör, zil paneli, dağıtıcı ve güç kaynağı olarak hazırlanmıştır.

V-BUS 9 EK CİHAZLAR

KAPICI FARKI 190,00\$

GÜVENLİK MONİTÖRÜ FARKI 548,00\$

GÖRÜNTÜLÜ VE SESLİ
İNTERKOM SİSTEMLERİ



DMY Elektrik Otomasyon Aydınlatma San. ve Tic. A.Ş.
www.dmyeo.com.tr



GÖRÜNTÜLÜ İNTERKOM SİSTEMLERİ

na·De®

V-BUS9 İNTERKOM BAĞLANTI ŞEMASI

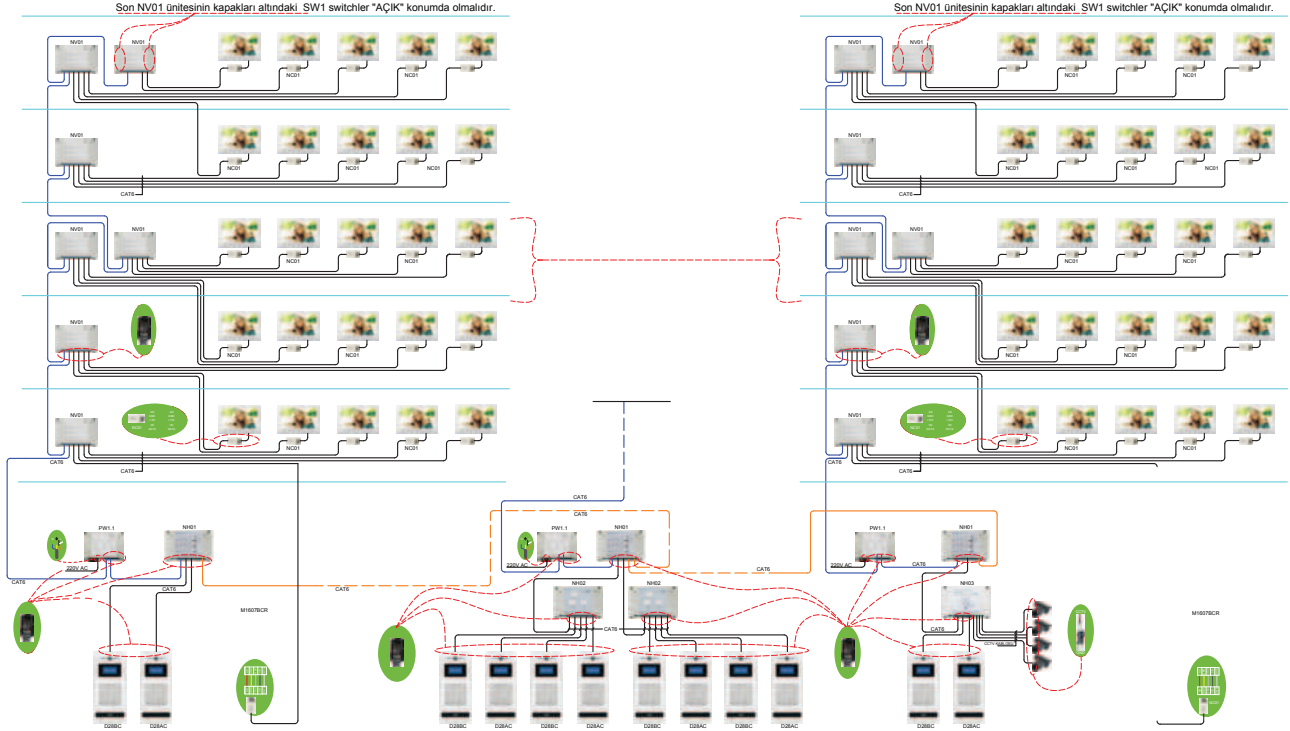

** V-BUS9 sistemlerinde ek tesisat ürünleri aşağıdaki açıklamalara göre verilmelidir.

- V-BUS9 sistemin kabloları şaftlı sistem olmalıdır.
- Kapıcı telefonu tercihe göre farklılık gösterebilir (M2307ADT - M280ADT).
- Güvenlik telefonunda kullanılacak kablo CAT6 olmalıdır.
- M1607BCR güvenlik telefonu ilave edildiğinde RJ-45 bağlantı soketi, NV01 dikey dağıtıcı, PW01.1 güç kaynağı ve NH01 dağıtıcı kullanılmalıdır.
- Blok sayısı arttıkça bu oranda NH01 yatay dağıtıcı kullanılmalıdır.

PW01.1 Güç Kaynağı Farkı

- Güç kaynağı kapasitesi aşağıdaki tabloda verilmiştir.
- Kapasite aşıldığı durumda PW01.1 ürünü ilave olarak verilmelidir.

KABLO ÇEŞİDİ

CAT5 - CAT6

MAX. MONİTÖR

20 Monitör

TBS GÖRÜNTÜLÜ İTERKOM SİSTEMLERİ

Monitör

- 4.3" TFT LCD ekran
- Kapı otomatiği açma tuşu
- Zil paneli kamerasını görüntüleyebilme
- Kapıcı ile görüşebilme
- Görüşme sesi seviye ayarı
- Renk, parlaklık ve kontrast ayarı menüsü
- Gizlilikli sesli ve görüntülü görüşme özelliği
- Monitör açık unutulduğunda sistemin otomatik olarak kapanması
- Bir blokta 20 daireye kadar devreye alınabilir
- Kolay montaj ve kablo bağlantısı
- DT-8 kablolarına uygun

Zil Paneli

- Santralsiz, koaksiyelsiz ve zil dönüşsüz sadece DT-8 ile bağlantı
- Rengi rengine bağlantı ile montaj kolaylığı
- Açısı 25° ayarlanabilir hareketli kamera (basic ve konsept panellerde)



GÖRÜNTÜLÜ İNTERKOM SİSTEMLERİ

na·De®

TBS GÖRÜNTÜLÜ İNTERKOM SİSTEMLERİ

ÜRÜN KODU	ÜRÜN ADI	KOLİ AD.	FİYAT
	TBS-430 4.3" Renkli Görüntülü Diafon	-	109,00 \$
	TBS-8CP Dijital Kameralı Zil Paneli	-	228,00 \$
	TBS-VY02 Video Yükseltici	-	59,00 \$
	TBS-VD02 Video Dağıtıcı	-	14,00 \$
	TBS-PW5A Güç Kaynağı Adaptör (5A)	-	50,00 \$
	TBS-PW3A Güç Kaynağı Adaptör (3A)	-	32,00 \$

GÖRÜNTÜLÜ VE SESLİ
İNTERKOM SİSTEMLERİ

PAKET FİYAT TABLOSU



DAİRE SAYISI	TBS
	4,3" MONİTÖR
	TBS-430
	ZİL PANELİ
	TBS-8CP
1	446,00 \$
2	555,00 \$
3	664,00 \$
4	773,00 \$
5	882,00 \$
6	991,00 \$
7	1.100,00 \$
8	1.209,00 \$
9	1.318,00 \$
10	1.427,00 \$
11	1.536,00 \$
12	1.645,00 \$
13	1.754,00 \$
14	1.863,00 \$
15	1.972,00 \$
16	2.081,00 \$
17	2.190,00 \$
18	2.299,00 \$
19	2.408,00 \$
20	2.517,00 \$

Tablodaki fiyatlara tesisat ek ürünleri eklenmemiş olup, fiyatlar; monitör, zil paneli, güç kaynağı olarak hazırlanmıştır.

GÖRÜNTÜLÜ İNTERKOM SİSTEMLERİ

na·De®

TBS BAĞLANTI ŞEMASI

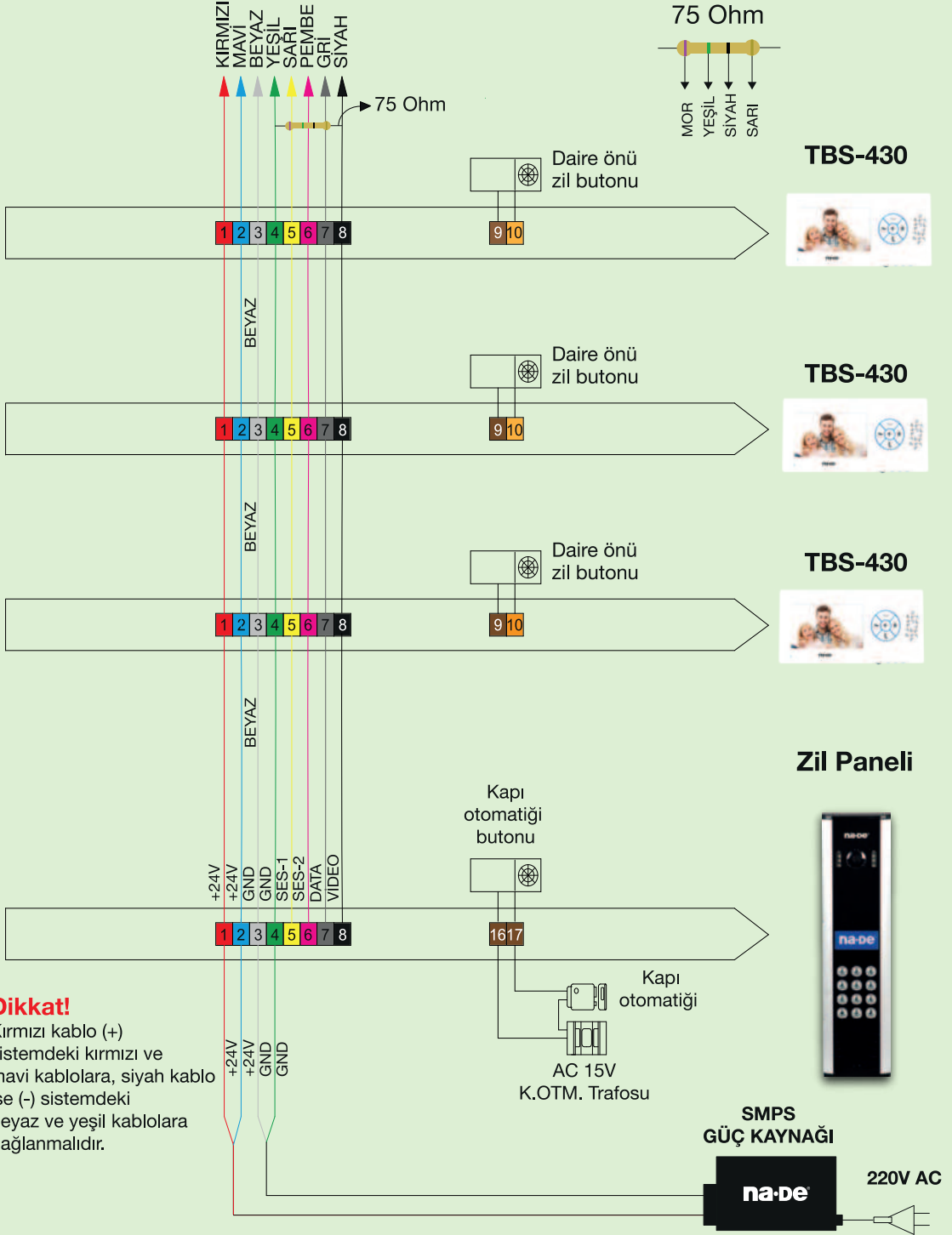

* Uygulamadaki kablolama yapısına göre, video dağıtıcı (VD02) ve video yükseltici (VY02) ihtiyacı olabilir. VD02 kullanıldığında ilave güç kaynağı ihtiyacı olacaktır

na·De®

VİLLA SET

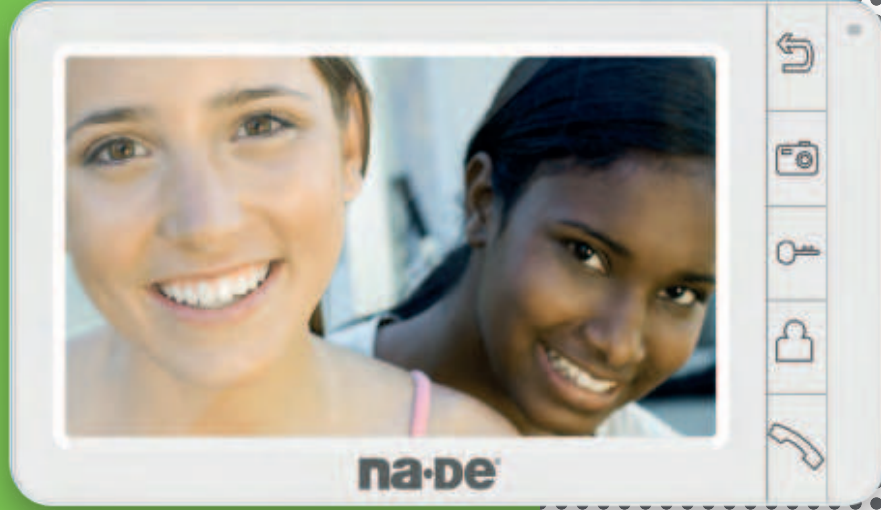

GÖRÜNTÜLÜ VE SESLİ
İTERKOM SİSTEMLERİ

GÖRÜNTÜLÜ İNTERKOM SİSTEMLERİ

na·De®

VİLLA SET

ÜRÜN KODU	ÜRÜN ADI	KOLİ AD.	FİYAT
07041EBM	7" Görüntülü Handsfree Renkli Monitör	1	284,00 \$
05104EBM	Renkli Kameralı Zil Paneli	1	152,00 \$
GK-10	Güç Kaynağı	1	107,00 \$
17041EBM	7" Görüntülü Handsfree 1'li Villa Set (4 Kablo)	1	548,00 \$
27041EBM	7" Görüntülü Handsfree 2'li Villa Set (4 Kablo)	1	828,00 \$
37041EBM	7" Görüntülü Handsfree 3'lü Villa Set (4 Kablo)	1	1112,00 \$
47041EBM	7" Görüntülü Handsfree 4'lü Villa Set (4 Kablo)	1	1395,00 \$

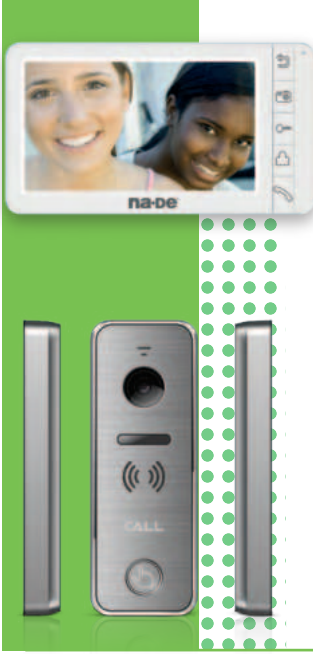

Villa Set

- 7" Yüksek çözünürlüklü LCD ekran
- Eller serbest (Handsfree) konuşma özelliği
- Kullanıcı dostu arayüz
- Monitörler arasında görüşme yapabilme
- Kapı otomatığı kontrolü
- Dış kapı ve istenilen CCTV kamerası görüntüleyebilme özelliği
- İlave monitör bağlama seçeneği
- İlave panel bağlama seçeneği
- Renkli kameralı zil paneli

NVIS SESLİ İNTERKOM SİSTEMLERİ

- Görüntülü istenmeyen daireler için ekonomik fiyatlı telefon ünitesi
- Telefon ahizesi açık unutulsa da aktif zil sesi
- Kapı otomatığı özelliği
- Zil sesi ayarı
- İki ayrı zil sesi ile daire kapı arama ve kapı önü zili melodisi
- Dijital adreslemeye uygun dip switch yapısı
- Gizlilikli görüşme özelliği
- Kolay montaj ve kablo bağlantısı
- Santralsiz, koaksiyelsiz ve zil dönüşsüz sadece DT-8 veya Cat-6 ile 4+2 kablo bağlantısı
- Kapıcı ile konuşma
- Dijital zil panelinde şifreli dış kapı açma ve proximity kart (RF-ID) ile dış kapı açma özelliği
- Bir blokta 127 daireye kadar devreye alınabilir



SESLİ İTERKOM SİSTEMLERİ

na·De®

NVIS SESLİ İTERKOM SİSTEMLERİ

	ÜRÜN KODU	ÜRÜN ADI	KOLİ AD.	FİYAT
	D29AC	NVIS Görüntüsüz Zil Paneli	36	134,00 \$
	D29BC	NVIS Görüntüsüz RF-ID Zil Paneli	36	160,00 \$
	N2901ADT	Daire içi telefon	244	63,00 \$
	N2902ADT	Daire içi telefon, Kapıcı ile görüşme	50	FİYAT SORUNUZ
	TBS-PW5A	Güç Kaynağı Adaptör (5A)	-	50,00 \$
	TBS-PW3A	Güç Kaynağı Adaptör (3A)	-	32,00 \$

GÖRÜNTÜLÜ VE SESLİ
İTERKOM SİSTEMLERİ

PAKET FİYAT TABLOSU



DAİRE SAYISI	NVIS	
	DAİRE İÇİ TELEFON	DAİRE İÇİ TELEFON
	N2901ADT	N2901ADT
	ZİL PANELİ	ZİL PANELİ
	D29AC.	D29BC.(KARTLI GEÇİŞ)
1	229,00 \$	255,00 \$
2	292,00 \$	318,00 \$
3	355,00 \$	381,00 \$
4	418,00 \$	444,00 \$
5	481,00 \$	507,00 \$
6	544,00 \$	570,00 \$
7	607,00 \$	633,00 \$
8	670,00 \$	696,00 \$
9	733,00 \$	759,00 \$
10	796,00 \$	822,00 \$
11	859,00 \$	885,00 \$
12	922,00 \$	948,00 \$
13	985,00 \$	1.011,00 \$
14	1.048,00 \$	1.074,00 \$
15	1.111,00 \$	1.137,00 \$
16	1.174,00 \$	1.200,00 \$
17	1.237,00 \$	1.263,00 \$
18	1.300,00 \$	1.326,00 \$
19	1.363,00 \$	1.389,00 \$
20	1.426,00 \$	1.452,00 \$
21	1.489,00 \$	1.515,00 \$
22	1.552,00 \$	1.578,00 \$
23	1.615,00 \$	1.641,00 \$
24	1.678,00 \$	1.704,00 \$
25	1.741,00 \$	1.767,00 \$

Tablodaki fiyatlara tesisat ek ürünleri eklenmemiş olup, fiyatlar; telefon, zil paneli, güç kaynağı olarak hazırlanmıştır.

SESLİ İTERKOM SİSTEMLERİ

na·De®

NVIS BAĞLANTI ŞEMASI

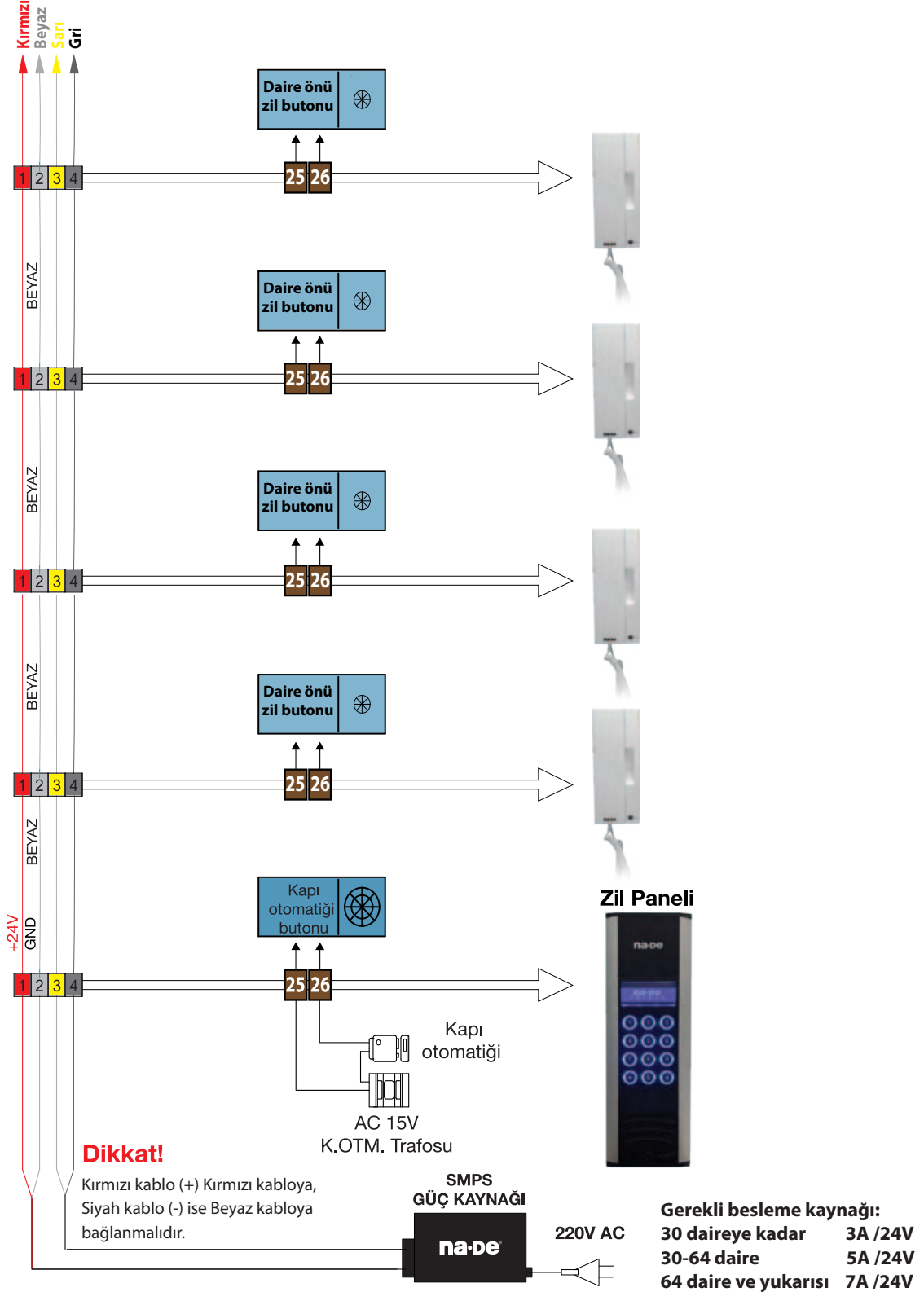

GÖRÜNTÜLÜ VE SESLİ
İTERKOM SİSTEMLERİ

60 DAİRE'YE KADAR EKONOMİK SETLER DİAFON SET



GÖRÜNTÜLÜ VE SESLİ
İNTERKOM SİSTEMLERİ

SESLİ İTERKOM SİSTEMLERİ

na·De®

4 DAİREYE KADAR EKONOMİK SETLER VİLA SET

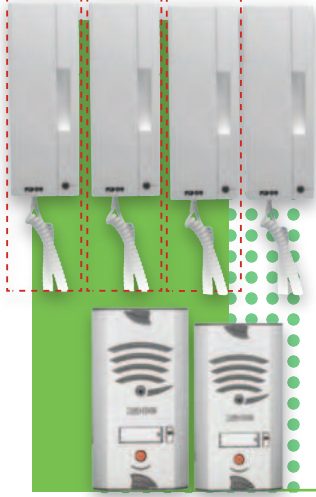

ÜRÜN KODU	ÜRÜN ADI	KOLİ AD.	FİYAT
90028	Villa Set 1 (1 Şube İçin)	10	198,00 \$
90029	Villa Set 2 (2 Şube İçin)	15	250,00 \$
90030	Villa Set 3 (3 Şube İçin)	12	295,00 \$
90031	Villa Set 4 (4 Şube İçin)	10	319,00 \$

60 DAİRE'YE KADAR EKONOMİK SETLER DİAFON SET



TES 01	Telefon Ekonomik Set (1 Daire İçin)	1	186,00 \$
TES 02	Telefon Ekonomik Set (2 Daire İçin)	1	239,00 \$
TES 03	Telefon Ekonomik Set (3 Daire İçin)	1	293,00 \$
TES 04	Telefon Ekonomik Set (4 Daire İçin)	1	348,00 \$
TES 05	Telefon Ekonomik Set (5 Daire İçin)	1	404,00 \$
TES 06	Telefon Ekonomik Set (6 Daire İçin)	1	458,00 \$
TES 07	Telefon Ekonomik Set (7 Daire İçin)	1	513,00 \$
TES 08	Telefon Ekonomik Set (8 Daire İçin)	1	566,00 \$
TES 09	Telefon Ekonomik Set (9 Daire İçin)	1	575,00 \$
TES 10	Telefon Ekonomik Set (10 Daire İçin)	1	672,00 \$
TES 11	Telefon Ekonomik Set (11 Daire İçin)	5	729,00 \$
TES 12	Telefon Ekonomik Set (12 Daire İçin)	5	784,00 \$

GÖRÜNTÜLÜ VE SESLİ
İTERKOM SİSTEMLERİ

SESLİ İTERKOM SİSTEMLERİ

na·De®

60 DAİRE'YE KADAR EKONOMİK SETLER DİAFON SET



ÜRÜN KODU	ÜRÜN ADI	KOLİ AD.	FİYAT
TES 13	Telefon Ekonomik Set (13 Daire İçin)	5	810,00 \$
TES 14	Telefon Ekonomik Set (14 Daire İçin)	5	854,00 \$
TES 15	Telefon Ekonomik Set (15 Daire İçin)	5	912,00 \$
TES 16	Telefon Ekonomik Set (16 Daire İçin)	5	957,00 \$
TES 17	Telefon Ekonomik Set (17 Daire İçin)	5	1017,00 \$
TES 18	Telefon Ekonomik Set (18 Daire İçin)	5	1061,00 \$
TES 19	Telefon Ekonomik Set (19 Daire İçin)	5	1117,00 \$
TES 20	Telefon Ekonomik Set (20 Daire İçin)	5	1161,00 \$
TES 24	Telefon Ekonomik Set (24 Daire İçin)	5	1411,00 \$
TES 40	Telefon Ekonomik Set (40 Daire İçin)	5	2.302,00 \$
TES 60	Telefon Ekonomik Set (60 Daire İçin)	5	3.391,00 \$

YENİ



4 DAİRE'YE KADAR EKONOMİK SETLER VİLA SET

NDTES 01	4+n Gizliliksiz Telefonlu 1'li Eko. Set	10	156,00 \$
NDTES 02	4+n Gizliliksiz Telefonlu 2'li Eko. Set	15	204,00 \$
NDTES 03	4+n Gizliliksiz Telefonlu 3'lü Eko. Set	12	253,00 \$
NDTES 04	4+n Gizliliksiz Telefonlu 4'lü Eko. Set	10	298,00 \$

GÖRÜNTÜLÜ VE SESLİ İTERKOM SİSTEMLERİ



DMY Elektrik Otomasyon Aydınlatma San. ve Tic. A.Ş.
www.dmyeo.com.tr



109



SESLİ İTERKOM SİSTEMLERİ

na·De®

ÜRÜN KODU	ÜRÜN ADI	KOLİ AD.	FİYAT
	50010 Kapı Görüşmeli Diafon Sistemleri	60	44,00 \$
	50040 Apartman Tipi Diafon Santrali	20	106,00 \$

ZİL TRANSFORMATÖRLERİ

GÖRÜNTÜLÜ VE SESLİ İTERKOM SİSTEMLERİ

	01004 12V / 4VA Zil Transformatörü	60	40,00 \$
	01002 15V / 15VA Zil Transformatörü	30	45,00 \$
	01003 24V / 15VA Zil Transformatörü	20	35,00 \$

SESLİ İTERKOM SİSTEMLERİ

na·De®

MULTİ APARTMAN DİAFON SİSTEMLERİ
HOPARLÖRLÜ

ÜRÜN KODU	ÜRÜN ADI	KOLİ AD.	FİYAT
HP01-208MM	8+n 1'li Tek Sıra Zil Paneli	-	81,00 \$
HP02-234MM	8+n 2'li Tek Sıra Zil Paneli	-	90,00 \$
HP03-261MM	8+n 3'lü Tek Sıra Zil Paneli	-	100,00 \$
HP04-287MM	8+n 4'lü Tek Sıra Zil Paneli	-	113,00 \$
HP05-313MM	8+n 5'li Tek Sıra Zil Paneli	-	123,00 \$
HP06-339MM	8+n 6'lı Tek Sıra Zil Paneli	-	133,00 \$
HP07-365MM	8+n 7'li Tek Sıra Zil Paneli	-	149,00 \$
HP08-391MM	8+n 8'li Tek Sıra Zil Paneli	-	158,00 \$
HP09-418MM	8+n 9'lu Tek Sıra Zil Paneli	-	168,00 \$
HP10-444MM	8+n 10'lu Tek Sıra Zil Paneli	-	185,00 \$
HP11-470MM	8+n 11'li Tek Sıra Zil Paneli	-	195,00 \$
HP12-496MM	8+n 12'li Tek Sıra Zil Paneli	-	206,00 \$



GÖRÜNTÜLÜ VE SESLİ
İTERKOM SİSTEMLERİ



DMY Elektrik Otomasyon Aydınlatma San. ve Tic. A.Ş.
www.dmyeo.com.tr



SESLİ İTERKOM SİSTEMLERİ

MULTİ APARTMAN DİAFON SİSTEMLERİ HOPARLÖRLÜ

ÜRÜN KODU	ÜRÜN ADI	KOLİ AD.	FİYAT
HPÇ02-208MM	8+n 2'li Çift Sıra Zil Paneli	-	89,00 \$
HPÇ04-234MM	8+n 4'lü Çift Sıra Zil Paneli	-	102,00 \$
HPÇ06-261MM	8+n 6'lı Çift Sıra Zil Paneli	-	115,00 \$
HPÇ08-287MM	8+n 8'li Çift Sıra Zil Paneli	-	128,00 \$
HPÇ10-313MM	8+n 10'lu Çift Sıra Zil Paneli	-	148,00 \$
HPÇ12-339MM	8+n 12'li Çift Sıra Zil Paneli	-	161,00 \$
HPÇ14-365MM	8+n 14'lü Çift Sıra Zil Paneli	-	175,00 \$
HPÇ16-391MM	8+n 16'lı Çift Sıra Zil Paneli	-	189,00 \$
HPÇ18-418MM	8+n 18'li Çift Sıra Zil Paneli	-	212,00 \$
HPÇ20-444MM	8+n 20'li Çift Sıra Zil Paneli	-	223,00 \$
HPÇ22-470MM	8+n 22'li Çift Sıra Zil Paneli	-	237,00 \$
HPÇ24-496MM	8+n 24'lü Çift Sıra Zil Paneli	-	252,00 \$



GÖRÜNTÜLÜ VE SESLİ
İTERKOM SİSTEMLERİ

SESLİ İTERKOM SİSTEMLERİ

na·De®

MULTİ APARTMAN DİAFON SİSTEMLERİ HOPARLÖRSÜZ

ÜRÜN KODU	ÜRÜN ADI	KOLİ AD.	FİYAT
HS04-208MM	8+n 4'lü Tek Sıra Ek Zil Paneli	-	88,00 \$
HS05-208MM	8+n 5'li Tek Sıra Ek Zil Paneli	-	96,00 \$
HS06-234MM	8+n 6'lı Tek Sıra Ek Zil Paneli	-	106,00 \$
HS07-261MM	8+n 7'li Tek Sıra Ek Zil Paneli	-	117,00 \$
HS08-287MM	8+n 8'li Tek Sıra Ek Zil Paneli	-	127,00 \$
HS09-313MM	8+n 9'li Tek Sıra Ek Zil Paneli	-	136,00 \$
HS10-339MM	8+n 10'lu Tek Sıra Ek Zil Paneli	-	150,00 \$
HS11-365MM	8+n 11'li Tek Sıra Ek Zil Paneli	-	160,00 \$
HS12-391MM	8+n 12'li Tek Sıra Ek Zil Paneli	-	174,00 \$
HS13-418MM	8+n 13'lü Tek Sıra Ek Zil Paneli	-	183,00 \$
HS14-444MM	8+n 14'lü Tek Sıra Ek Zil Paneli	-	190,00 \$
HS15-470MM	8+n 15'li Tek Sıra Ek Zil Paneli	-	200,00 \$



GÖRÜNTÜLÜ VE SESLİ
İTERKOM SİSTEMLERİ



Đedal
EVPU

DMY Elektrik Otomasyon Aydınlatma San. ve Tic. A.Ş.
www.dmyeo.com.tr

DMY
ELEKTRİK OTOMASYON AYDINLATMA

SESLİ İTERKOM SİSTEMLERİ

na·De®

MULTİ APARTMAN DİAFON SİSTEMLERİ HOPARLÖRSÜZ

ÜRÜN KODU	ÜRÜN ADI	KOLİ AD.	FİYAT
HS05-234MM	8+n 5'li Tek Sıra Ek Zil Paneli	-	98,00 \$
HS06-261MM	8+n 6'lı Tek Sıra Ek Zil Paneli	-	107,00 \$
HS07-287MM	8+n 7'li Tek Sıra Ek Zil Paneli	-	119,00 \$
HS08-313MM	8+n 8'li Tek Sıra Ek Zil Paneli	-	129,00 \$
HS09-339MM	8+n 9'li Tek Sıra Ek Zil Paneli	-	138,00 \$
HS10-365MM	8+n 10'lu Tek Sıra Ek Zil Paneli	-	152,00 \$
HS11-391MM	8+n 11'li Tek Sıra Ek Zil Paneli	-	162,00 \$
HS12-418MM	8+n 12'li Tek Sıra Ek Zil Paneli	-	175,00 \$
HS13-444MM	8+n 13'lü Tek Sıra Ek Zil Paneli	-	183,00 \$
HS14-470MM	8+n 14'lü Tek Sıra Ek Zil Paneli	-	193,00 \$
HS15-496MM	8+n 15'li Tek Sıra Ek Zil Paneli	-	204,00 \$
HS16-496MM	8+n 16'lı Tek Sıra Ek Zil Paneli	-	211,00 \$



GÖRÜNTÜLÜ VE SESLİ
İTERKOM SİSTEMLERİ

SESLİ İTERKOM SİSTEMLERİ

na·De®

MULTİ APARTMAN DİAFON SİSTEMLERİ HOPARLÖRSÜZ

ÜRÜN KODU	ÜRÜN ADI	KOLİ AD.	FİYAT
HŞÇ08-208MM	8+n 8li Çift Sıra Ek Zil Paneli	-	102,00 \$
HŞÇ10-208MM	8+n 10lu Çift Sıra Ek Zil Paneli	-	113,00 \$
HŞÇ12-261MM	8+n 12li Çift Sıra Ek Zil Paneli	-	132,00 \$
HŞÇ14-287MM	8+n 14lü Çift Sıra Ek Zil Paneli	-	149,00 \$
HŞÇ16-313MM	8+n 16lı Çift Sıra Ek Zil Paneli	-	159,00 \$
HŞÇ18-339MM	8+n 18li Çift Sıra Ek Zil Paneli	-	176,00 \$
HŞÇ20-365MM	8+n 20li Çift Sıra Ek Zil Paneli	-	190,00 \$
HŞÇ22-391MM	8+n 22li Çift Sıra Ek Zil Paneli	-	204,00 \$
HŞÇ24-418MM	8+n 24lü Çift Sıra Ek Zil Paneli	-	217,00 \$
HŞÇ26-444MM	8+n 26lı Çift Sıra Ek Zil Paneli	-	232,00 \$
HŞÇ28-470MM	8+n 28li Çift Sıra Ek Zil Paneli	-	246,00 \$
HŞÇ30-496MM	8+n 30lu Çift Sıra Ek Zil Paneli	-	260,00 \$

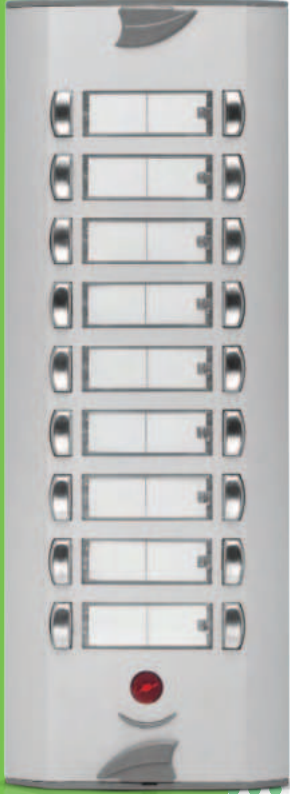

GÖRÜNTÜLÜ VE SESLİ
İTERKOM SİSTEMLERİ



DMY Elektrik Otomasyon Aydınlatma San. ve Tic. A.Ş.
www.dmyeo.com.tr



SESLİ İTERKOM SİSTEMLERİ

na·De®

MULTİ APARTMAN DİAFON SİSTEMLERİ HOPARLÖRSÜZ

ÜRÜN KODU

ÜRÜN ADI

KOLİ AD.

FİYAT

HSC10-234MM	8+n 10lu Çift Sıra Ek Zil Paneli	-	115,00 \$
HSC12-234MM	8+n 12li Çift Sıra Ek Zil Paneli	-	130,00 \$
HSC14-261MM	8+n 14lü Çift Sıra Ek Zil Paneli	-	144,00 \$
HSC16-287MM	8+n 16li Çift Sıra Ek Zil Paneli	-	157,00 \$
HSC18-313MM	8+n 18li Çift Sıra Ek Zil Paneli	-	175,00 \$
HSC20-339MM	8+n 20li Çift Sıra Ek Zil Paneli	-	188,00 \$
HSC22-365MM	8+n 22li Çift Sıra Ek Zil Paneli	-	202,00 \$
HSC24-391MM	8+n 24lü Çift Sıra Ek Zil Paneli	-	215,00 \$
HSC26-418MM	8+n 26li Çift Sıra Ek Zil Paneli	-	232,00 \$
HSC28-444MM	8+n 28li Çift Sıra Ek Zil Paneli	-	244,00 \$
HSC30-470MM	8+n 30lu Çift Sıra Ek Zil Paneli	-	257,00 \$
HSC32-496MM	8+n 32li Çift Sıra Ek Zil Paneli	-	272,00 \$

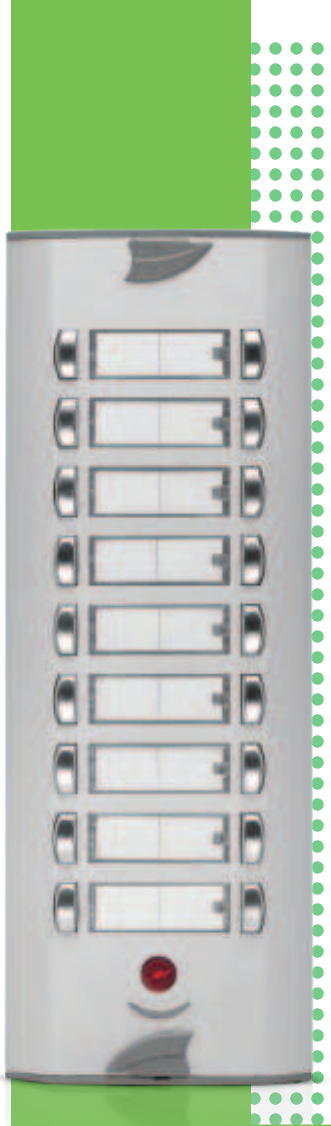

GÖRÜNTÜLÜ VE SESLİ
İTERKOM SİSTEMLERİ

SESLİ İTERKOM SİSTEMLERİ

na·De®

ZİL BUTONLARI

ÜRÜN KODU	ÜRÜN ADI	KOLİ AD.	FİYAT
07001	80mm - 1 Buton	5	13,00 \$
07002	105mm - 2 Buton	5	18,00 \$
07003	135mm - 3 Buton	5	23,00 \$
07004	155mm - 4 Buton	5	29,00 \$
07005	185mm - 5 Buton	5	34,00 \$
07006	210mm - 6 Buton	5	39,00 \$
07007	240mm - 7 Buton	5	45,00 \$
07008	265mm - 8 Buton	5	50,00 \$
07009	295mm - 9 Buton	5	55,00 \$
07010	320mm - 10 Buton	5	62,00 \$



GÖRÜNTÜLÜ VE SESLİ
İTERKOM SİSTEMLERİ



DMY Elektrik Otomasyon Aydınlatma San. ve Tic. A.Ş.
www.dmyeo.com.tr



117

YANGIN ALGILAMA VE
UYARI SİSTEMLERİ



na·de®

Çevrimden Beslemeli Soket Altı Siren + Uyarı Işığı
7000M Serisinde Senaryoda Kullanma Opsiyonu

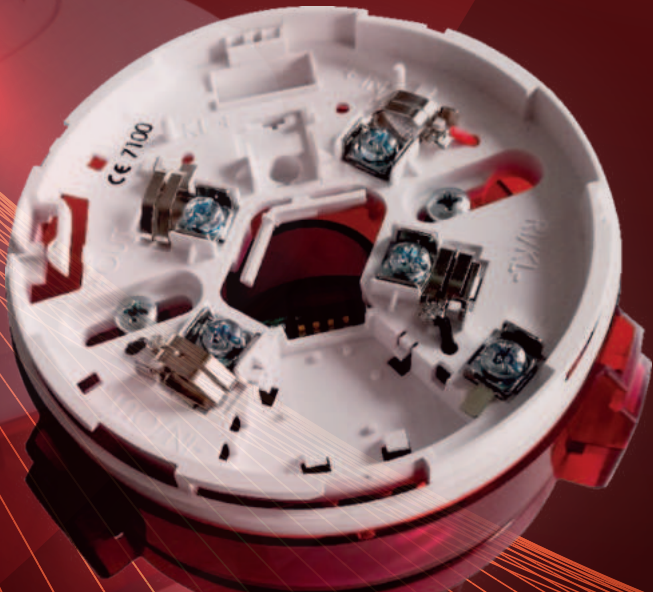

ADRESLENEBİLİR MODÜLER YANGIN ALGILAMA VE UYARI SİSTEMLERİ

- Adresleme cihazına ihtiyaç duyulmadan panel üzerinden otomatik adresleme
- Yangın ve arıza durumları (kısa devre, hat kopması vs.) için sürekli kontrol
- Printer opsiyonu ile olayları anlık yazdırılabilme
- Arttırılabilen Loop-Çevrim yapısı
- Her çevrim 210 adres kapasitesi
- Panelde 2.100 adres kapasitesi
- Network kablolama ile dağıtılmış yapıda çalışma özelliği
- Arıza durumu için ayırt edilebilir ses tonlu dahili buzzer
- Çoklu dil seçeneği
- Kontrol süresini tek tuşla uzatabilme özelliği
- TAHLİYE fonksiyonu ile tüm çıkışları aktif edebilme özelliği



7000M SERİSİ

- Gece / Gündüz çalışma modu özelliği
- Santral test modu özelliği
- Santral çevrimine bağlanabilen giriş/çıkış modülleri
- EN 54-2 ve EN 54-4 standartlarına uygunluk
- Çevrimdeki cihaz tipi ve parametrelerinin otomatik olarak algılanması
- Çevrimden sökülen cihazların algılanması
- Santral ve çevrim üzerindeki aygıtlar arasında iki yönlü bilgi alışverişi
- Gerçek zaman saati
- Elektromanyetik girişimlere karşı koruma
- Yüzey montaj teknolojisi ile üretim

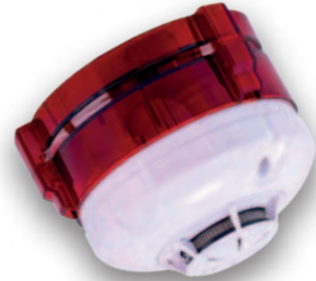

YANGIN ALGILAMA VE UYARI SİSTEMLERİ (7000M SERİSİ)

na·De®

ADRESLENEBİLİR

ÜRÜN KODU

ÜRÜN ADI

KOLİ AD.

FİYAT



ADRESLENEBİLİR

7000M_NADE

Adreslenebilir Yangın Alarm Paneli 2x32 Bölge

1

2.318,30€



ADRESLENEBİLİR

7000M-P_NADE

Adreslenebilir Yangın Alarm Paneli Printer 32 Bölge

1

2.863,80€



ADRESLENEBİLİR

7000M BIO_NADE

7000M BIO Modül (Giriş/Çıkış Modülü) DIN Uyumlu

63

409,20 €



ADRESLENEBİLİR

7000M LC_NADE

7000M Loop Kartı 2 Loop 420 Adres DIN Uyumlu

63

545,50€



ADRESLENEBİLİR

7000M-R_NADE

Adreslenebilir Tekrarlayıcı Panel

6

488,30€

YANGIN ALGILAMA VE UYARI SİSTEMLERİ

120

DMY
ELEKTRİK OTOMASYON AYDINLATMA

DMY Elektrik Otomasyon Aydınlatma San. ve Tic. A.Ş.
www.dmyeoa.com.tr

TSE

TÜVRheinland

RoHS

CE

EAC

TÜRKAKB

Đedal
EVPÜ

YANGIN ALGILAMA VE UYARI SİSTEMLERİ (7000M SERİSİ)

ADRESLENEBİLİR

ÜRÜN KODU

ÜRÜN ADI

KOLİ AD.

FİYAT

YENİ



ADRESLENEBİLİR

7000M-L_NADE

Adreslenebilir Bölge Gösterge Paneli
2x32 Bölge

6

488,30 €

YENİ



ADRESLENEBİLİR

FD7120M_NADE

Adreslenebilir Isı Artış Dedektörü İzolatörlü

100

35,80 €

YENİ



ADRESLENEBİLİR

FD7130M_NADE

Adreslenebilir Optik Duman Dedektörü
İzolatörlü

100

39,10 €

YENİ



ADRESLENEBİLİR

FD7160M_NADE

Adreslenebilir Kombine Dedektörü İzolatörlü

100

48,90 €

YENİ



ADRESLENEBİLİR

FD7150M_NADE

Adreslenebilir Yangın Alarm Butonu İzolatörlü

96

44,50 €

YANGIN ALGILAMA VE UYARI SİSTEMLERİ (7000M SERİSİ)

na·De®

ADRESLENEBİLİR

ÜRÜN KODU

ÜRÜN ADI

KOLİ AD.

FİYAT



ADRESLENEBİLİR

FD71CNG_NADE

Adreslenebilir Gaz Dedektörü_Nade (TypA)

-

53,40 €

*** 24V DC Harici Besleme Gereklidir

YENİ

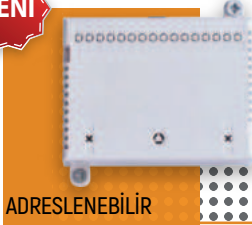

ADRESLENEBİLİR

FD7203M_NADE

Adreslenebilir Harici 1 Grş/1 Çkş Modl İzolatörlü

60

109,10 €

YENİ



ADRESLENEBİLİR

FD7206M_NADE

Adreslenebilir Flaşörlü Siren İzolatörlü

100

68,20 €

YENİ



ADRESLENEBİLİR

FD7205M_NADE

Dahili Sirenli Dedektör Tabanı

-

55,50 €



ADRESLENEBİLİR

DB7100_NADE

Dedektör Tabanı_NADE

-

4,60 €

YANGIN ALGILAMA VE UYARI SİSTEMLERİ

122

DMY
ELEKTRİK OTOMASYON AYDINLATMA

DMY Elektrik Otomasyon Aydınlatma San. ve Tic. A.Ş.
www.dmyeoa.com.tr

TSE

TÜV Rheinland

RoHS

CE

EAC

TÜRKAKB

Dedal
EVPÜ

YANGIN ALGILAMA VE UYARI SİSTEMLERİ (7000M SERİSİ)

ADRESLENEBİLİR

ÜRÜN KODU

ÜRÜN ADI

KOLİ AD.

FİYAT

YENİ

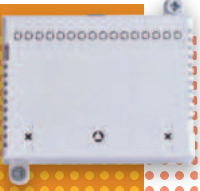

ADRESLENEBİLİR

FD7201M_NADE

Konvansiyonel Sistemi Adresleme Adaptörü

100

FİYAT
SORUNUZ

YENİ



ADRESLENEBİLİR

ADRESLENEBİLİR - KONVANSİYONEL (HİBRİT)

7000-1MC_NADE

7000-1MC Adreslenebilir / Konvansiyonel Hibrit Yangın Algılama Paneli

100

FİYAT
SORUNUZ

YENİ



ADRESLENEBİLİR

7000-1MC-8CL_NADE

7000-1MC Konvansiyonel Bölge Kartı (8 Bölge)

96

FİYAT
SORUNUZ

YENİ



ADRESLENEBİLİR

7000-1MC-BIO_NADE

7000-1MC Bio Modül (Giriş/Çıkış Modülü) DIN Uyumlu

96

FİYAT
SORUNUZ

ADRESLENEBİLİR MODÜLER YANGIN ALGILAMA VE UYARI SİSTEMLERİ

- Elektromanyetik girişimlere karşı koruma
- Yangın ve arıza durumları (kısa devre, hat kopması vs.) için sürekli kontrol
- Çevrimdeki cihaz tipi ve parametrelerinin otomatik olarak algılanması
- Çevrimden sökülen cihazların algılanması
- Santral ve çevrim üzerindeki aygıtlar arasında iki yönlü bilgi alışverişi
- İki aşamalı yangın koşulu, her bölge için ayrı programlanabilir süre
- Alarm bekleme süresinin ekrandan takip edilebileceği geri sayım sayacı
- Yangın durumu için ayırt edilebilir ses tonlu dahili buzzer
- Arıza durumu için ayırt edilebilir ses tonlu dahili buzzer
- FS5200E yangın söndürme santraliyle network çalışabilme seçeneği
- "Na-De INTELLECT" ile yangın algılama sisteminin grafiksel olarak pc üzerinden izlenebilmesi





IFS7002 SERİSİ

- Dokunmatik grafik LCD ekran ile kullanım kolaylığı
- Çoklu dil seçeneği
- EN 54-2 ve EN 54-4 standartlarına uygunluk
- IFS 7002 serisi adresli panellerle network çalışabilme
- Türkçe ve İngilizce menü
- Santral çevrimine bağlanabilen giriş/çıkış modülleri
- Gece / gündüz çalışma modu
- Yüzey montaj teknolojisi ile üretim



YANGIN ALGILAMA VE UYARI SİSTEMLERİ (IFS7002 SERİSİ)

ADRESLENEBİLİR

ADRESLENEBİLİR	ÜRÜN KODU	ÜRÜN ADI	KOLİ AD.	FİYAT
	IFS7002_NADE	1 Çevrim (Loop) Yangın Alarm Santrali	1	872,80 €
	IFS7002/2_NADE	2 Çevrim (Loop) Yangın Alarm Santrali	1	1,568,30€
	IFS7002/4_NADE	4 Çevrim (Loop) Yangın Alarm Santrali	1	1,950,10 €
	IFS7002R_NADE	Tekrarlama Santrali	1	872,80 €
	FD7110_NADE	Sabit Isı Dedektörü	100	34,30 €

YANGIN ALGILAMA VE UYARI SİSTEMLERİ (IFS7002 SERİSİ)

na·De®

ADRESLENEBİLİR

ÜRÜN KODU

ÜRÜN ADI

KOLİ AD.

FİYAT



ADRESLENEBİLİR

FD7120_NADE

Sabit Isı ve Isı Artış Dedektörü

100

34,40 €



ADRESLENEBİLİR

FD7130_NADE

Optik Duman Dedektörü

100

37,70 €



ADRESLENEBİLİR

FD7160_NADE

Kombine (Duman ve Isı) Dedektörü

100

46,80 €



ADRESLENEBİLİR

FD7150_NADE

Yangın Alarm Butonu

100

39,50 €



ADRESLENEBİLİR

FD71CNG_NADE

Gaz Dedektörü (Metan)

96

53,40 €

*** 24V DC Harici Besleme Gereklidir

YANGIN ALGILAMA VE UYARI SİSTEMLERİ

126

DMY
ELEKTRİK OTOMASYON AYDINLATMA

DMY Elektrik Otomasyon Aydınlatma San. ve Tic. A.Ş.
www.dmyeoa.com.tr

TSE

TÜVRheinland

RoHS

CE

EAC

TÜRKAKK

Dedal
EVPÜ

YANGIN ALGILAMA VE UYARI SİSTEMLERİ (IFS7002 SERİSİ)

ADRESLENEBİLİR

ÜRÜN KODU	ÜRÜN ADI	KOLİ AD.	FİYAT
FD7203 10/16_NADE	10 Giriş - 16 Çıkış Modül	-	272,80 €
*** 24V DC Harici Besleme Gereklidir			



ADRESLENEBİLİR

FD7203 3/6_NADE	3 Giriş - 6 Çıkış Modül	60	136,40 €
*** 24V DC Harici Besleme Gereklidir			



ADRESLENEBİLİR

FD7203_NADE	1 Giriş - 1 Çıkış Modülü	100	158,20 €
-------------	--------------------------	-----	----------

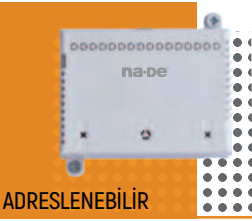

ADRESLENEBİLİR

FD7201SA_NADE	Konvansiyonel Sistemi Adresleme Adaptörü (Harici Beslemeli)	-	60,10 €
*** 24V DC Harici Besleme Gereklidir			

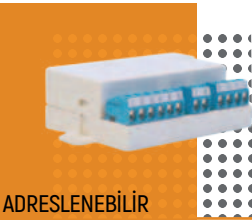

ADRESLENEBİLİR

FD7201S_NADE	Konvansiyonel Sistemi Adresleme Adaptörü	-	51,10 €
*** DB7100A ile Birlikte Kullanılır			
*** 1 Çevrime Maksimum 5 Adet Bağlanır			



ADRESLENEBİLİR

YANGIN ALGILAMA VE UYARI SİSTEMLERİ (IFS7002 SERİSİ)

na·De®

ADRESLENEBİLİR

ÜRÜN KODU

ÜRÜN ADI

KOLİ AD.

FİYAT

YENİ



ADRESLENEBİLİR

FD7205M_NADE

Dahili Sirenli Dedektör Tabanı

-

55,50 €

ADRESLENEBİLİR



FD7204F_NADE

Adreslenebilir Dahili Siren + Uyarı Işığı

-

70,10 €

*** DB7100 Standart Taban ile Kullanılır

ADRESLENEBİLİR



FD7204D_NADE

Adreslenebilir Dahili Siren + Uyarı Işığı

-

59,50 €

ADRESLENEBİLİR



FD7204_NADE

Adreslenebilir Dahili Siren

-

59,50 €

ADRESLENEBİLİR



DB7100_NADE

Standart Taban

315

4,60 €

ADRESLENEBİLİR



DB7100A_NADE

FD7201S için Taban

-

13,70 €

YANGIN ALGILAMA VE UYARI SİSTEMLERİ

128

DMY
ELEKTRİK OTOMASYON AYDINLATMA

DMY Elektrik Otomasyon Aydınlatma San. ve Tic. A.Ş.
www.dmyeoa.com.tr

TSE

TÜVRheinland

RoHS

CE

EAC

TÜRKAKB

Đedal
EVPÜ

YANGIN ALGILAMA VE UYARI SİSTEMLERİ (IFS7002 SERİSİ)

ADRESLENEBİLİR

ÜRÜN KODU

ÜRÜN ADI

KOLİ AD.

FİYAT



ADRESLENEBİLİR

YKB02A_NADE

Kanal Tipi Duman Dedektörü

315

176,60 €

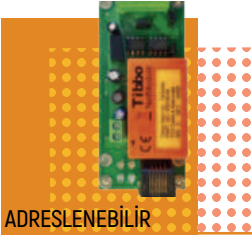

ADRESLENEBİLİR

RS-LAN_NADE

RS-LAN Arayüz Modülü

341,00 €

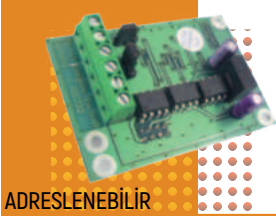

ADRESLENEBİLİR

RS 232/485_NADE

Arayüz Modülü

-

108,20 €

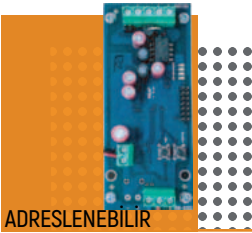

ADRESLENEBİLİR

MODBUS RTU_NADE

BMS Modülü

-

493,30 €

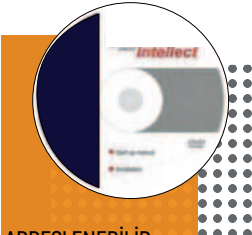

ADRESLENEBİLİR

INTELLECT YAZILIM_NADE

Intellect Bilgisayarlı İzleme Yazılımı

-

1.371,8 €

KONVANSİYONEL YANGIN ALARM SİSTEMLERİ

KONVANSİYONEL YANGIN ALGILAMA SANTRALLERİ GENEL ÖZELLİKLERİ

FS4000 SERİSİ

- EN 54-2 EN 54-4 standartlarına uygunluk
- 2-4-6-8 bölge sayısı
- Kolay kurulum, ledli gösterim
- Her bölge için ek yangın röle çıkışı opsiyonu
- Çıkışlara 1-7 dk gecikme atayabilme
- Her bölge için test modu ve devre dışı bırakabilme
- FS5200R Konvansiyonel tekraralama santrali ile uygunluk
- Tekrarlama paneli ile 15 panele kadar network çalışabilme
- Yangın çıkışlarını devre dışı bırakabilme
- Siren hatası, toprak hatası, şebeke hatası, akü hatası gösterimi
- 2 adet yangın rölesi
- 2 adet konvansiyonel siren çıkışı
- 1 adet arıza rölesi çıkışı



FS5200 SERİSİ

- 1 Adet siren çıkışı
- 2 Adet yangın için röle çıkışı
- 1 Adet arıza için röle çıkışı
- Genişleme modülleri ile bölge sayısını arttırabilme (8-16-24-32)
- Kalıcı arşiv hafızası
- 256 Olay kaydı
- FS5200R Konvansiyonel tekraralama santrali ile uyumluluk

FS5100 SERİSİ

- 2 Adet yangın hattı
- 2 Adet siren çıkışı
- 2 Adet yangın için röle çıkışı
- 1 Adet arıza için röle çıkışı
- Genişleme modülleri ile bölge sayısını arttırabilme (2-5-8)
- Kalıcı arşiv hafızası
- 84 Olay kaydı
- FS5200R Konvansiyonel tekraralama santrali ile uyumluluk



YANGIN ALGILAMA VE UYARI SİSTEMLERİ

KONVANSİYONEL



KONVANSİYONEL

ÜRÜN KODU	ÜRÜN ADI	KOLİ AD.	FİYAT
FS4000/2_NADE	2 Bölge Yangın Alarm Santrali	6	185,50 €
FS4000/4_NADE	4 Bölge Yangın Alarm Santrali	6	204,60 €
FS4000/6_NADE	6 Bölge Yangın Alarm Santrali	6	245,50 €
FS4000/8_NADE	8 Bölge Yangın Alarm Santrali	6	267,30 €

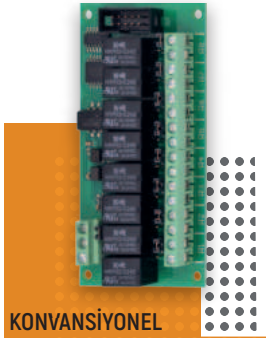

KONVANSİYONEL

FD4201/2_NADE	FS4000 Seri Genişleme Modülü (Bölgesel 2 Röle Çıkışı)	-	59,30 €
FD4201/4_NADE	FS4000 Seri Genişleme Modülü (Bölgesel 4 Röle Çıkışı)	-	141,10 €
FD4201/6_NADE	FS4000 Seri Genişleme Modülü (Bölgesel 6 Röle Çıkışı)	-	83,30 €
FD4201/8 (V1)_NADE	FS4000 Seri Genişleme Modülü (Bölgesel 8 Röle Çıkışı)	-	132,50 €
FD4201/8 (V2)_NADE	FS4000 Seri Genişleme Modülü (Bölgesel 8 Röle Çıkışı)	-	132,50 €



KONVANSİYONEL

FS5100_NADE	2 Bölge Yangın Alarm Santrali	-	913,70 €
-------------	-------------------------------	---	----------

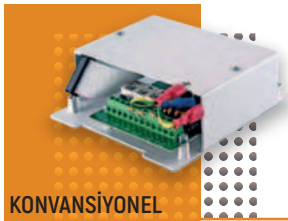

KONVANSİYONEL

5101_NADE	FS5100 Serisi Genişleme Modülü (3 Bölge + 3 Role)	-	191,00 €
-----------	---	---	----------

YANGIN ALGILAMA VE UYARI SİSTEMLERİ

na·de®

KONVANSİYONEL

ÜRÜN KODU

ÜRÜN ADI

KOLİ AD.

FİYAT

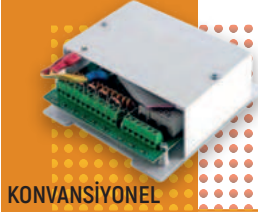

KONVANSİYONEL

5102_NADE

FS5100 Serisi Genişleme Modülü
(6 Bölge + 3 Role)

-

204,60 €



KONVANSİYONEL

FS5200_NADE

8 Bölge Yangın Alarm Santrali

-

954,60 €



KONVANSİYONEL

5201_NADE

FS5200 Serisi Genişleme Modülü (8 Bölge)

315

270,80 €



KONVANSİYONEL

5202_NADE

FS5200 Serisi Genişleme Modülü
(8 Bölge + 1 Siren)

-

270,80 €



KONVANSİYONEL

5203_NADE

FS5200 Serisi Genişleme Modülü (8 Röle)

-

165,80 €

*** Sadece 1 Modül Eklenebilir.

YANGIN ALGILAMA VE UYARI SİSTEMLERİ

132

 **DMY**
ELEKTRİK OTOMASYON AYDINLATMA

DMY Elektrik Otomasyon Aydınlatma San. ve Tic. A.Ş.
www.dmyeoa.com.tr















YANGIN ALGILAMA VE UYARI SİSTEMLERİ

KONVANSİYONEL

ÜRÜN KODU

ÜRÜN ADI

KOLİ AD.

FİYAT

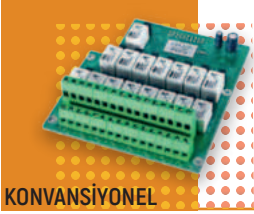

KONVANSİYONEL

5204_NADE

FS5200 Serisi Genişleme Modülü (16 Röle)

-

365,90 €

*** Sadece 1 Modül Eklenebilir.



KONVANSİYONEL

FS5200R_NADE

Tekrarlama Paneli

-

681,90 €



KONVANSİYONEL

FD8010_NADE

Sabit Isı Dedektörü

100

21,60 €



KONVANSİYONEL

FD8020_NADE

Isı Artış Dedektörü

100

21,60 €



KONVANSİYONEL

FD8030_NADE

Optik Duman Dedektörü

100

22,70 €

YANGIN ALGILAMA VE UYARI SİSTEMLERİ

na·De®

KONVANSİYONEL

ÜRÜN KODU

ÜRÜN ADI

KOLİ AD.

FİYAT



KONVANSİYONEL

FD8060_NADE

Kombine (Optik Duman + Isı) Dedektörü

100

28,10 €



KONVANSİYONEL

FD8040_NADE

Nokta Tipi Alev Dedektörü

100

68,20 €



KONVANSİYONEL

YKB02K_NADE

Kanal Tipi Duman Dedektörü

191,00 €



KONVANSİYONEL

DB8000_NADE

Standart Taban

315

4,10 €



KONVANSİYONEL

FD3050_NADE

Yangın Algılama Butonu

96

24,90 €

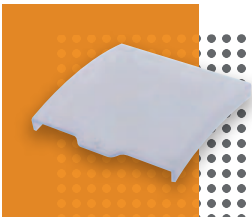

TK_NADE

FD7150 ve FD3050 Serisi İçin
Plastik Şeffaf Kapak

50

2,20 €

YANGIN ALGILAMA VE
UYARI SİSTEMLERİ

YANGIN ALGILAMA VE UYARI SİSTEMLERİ

KONVANSİYONEL

ÜRÜN KODU

ÜRÜN ADI

KOLİ AD.

FİYAT

YENİ



KONVANSİYONEL

FD7205M_NADE

Dahili Sirenli Dedektör Tabanı

-

55,50 €



KONVANSİYONEL

FD8204CS_NADE

Dahili Siren

96

29,00 €



KONVANSİYONEL

SB112F_NADE

Harici Siren

-

68,20 €



KONVANSİYONEL

RI31_NADE

Paralel İhbar Lambası

-

5,60 €



KONVANSİYONEL

RI31S_NADE

Mesafe Ses Göstergesi (Buzzer)

-

9,80 €

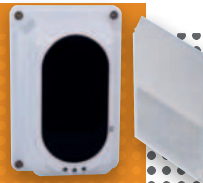

KONVANSİYONEL

AW-BK901

8-100 mt Işın Tipi Reflektörlü Duman Dedektörü (Beam)

-

FİYAT SORUNUZ

*** 24V DC Harici Besleme Gereklidir

YANGIN ALGILAMA VE UYARI SİSTEMLERİ

KONVANSİYONEL

ÜRÜN KODU

ÜRÜN ADI

KOLİ AD.

FİYAT



KONVANSİYONEL

SBD-TOD-0590

Su Basma Dedektörü

-

FİYAT SORUNUZ

*** 24V DC Harici Besleme Gereklidir



KONVANSİYONEL

FXDC0

Karbonmonoksit Dedektörü
(Şarjlı Pili + Elektrikli)

-

FİYAT SORUNUZ

FXDC01

Karbonmonoksit Dedektörü
(Pili + Elektrikli)

-

FİYAT SORUNUZ



KONVANSİYONEL

NYS3

Doğal Gaz Dedektörü 220V

-

FİYAT SORUNUZ

NYS1

Doğal Gaz Dedektörü 12-24V

-

FİYAT SORUNUZ



KONVANSİYONEL

AKV01

4,5Ah/12V Akü

-

FİYAT SORUNUZ

AKV02

18Ah/12V Akü

-

FİYAT SORUNUZ

AKV03

26Ah/12V Akü

-

FİYAT SORUNUZ

*** Fiyat Bilgisi için Satış Temsilcisine Danışınız



KONVANSİYONEL

CYS-4024

24V/1,5A Güç Kaynağı/Adaptörü

-

FİYAT SORUNUZ

CYS-9024

24V/3,8A Güç Kaynağı/Adaptörü

-

FİYAT SORUNUZ

CYS-12024

24V/5A Güç Kaynağı/Adaptörü

-

FİYAT SORUNUZ

CYS-18024

24V/7,5A Güç Kaynağı/Adaptörü

-

FİYAT SORUNUZ

YANGIN ALGILAMA VE UYARI SİSTEMLERİ

KONVANSİYONEL

ÜRÜN KODU

ÜRÜN ADI

KOLİ AD.

FİYAT



FS5200P_NADE

Anahtarlamalı Güç Kaynağı

-

381,90 €

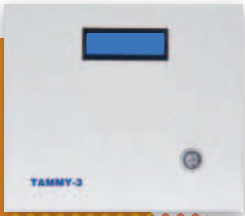

TAMMY2

Deprem Sensörü

-

FİYAT
SORUNUZ

TAMMY3

Deprem Sensörü

-

FİYAT
SORUNUZ

YENİ



NOFIRE

Deprem Sensörü

1

317,20 €



AC8002_NADE

Nemli Ortam Sıva Üstü Montaj Aparatı

-

11,80 €



AC8001_NADE

Sıva Üstü Montaj Aparatı

-

2,20 €

YANGIN ALGILAMA VE UYARI SİSTEMLERİ

na·De®

KONVANSİYONEL

ÜRÜN KODU

ÜRÜN ADI

KOLİ AD.

FİYAT



KONVANSİYONEL

ESF24-FLŞ

Ledli Flaşör 24VDC

-

FİYAT
SORUNUZ



KONVANSİYONEL

TD200

Otomatik Telefon Arama Cihazı

-

FİYAT
SORUNUZ



KONVANSİYONEL

DB8000R_NADE

Röleli Dedektör Tabanı

315

13,70 €



KONVANSİYONEL

ECS120

Dahili Siren ve Uyarı Işığı

315

FİYAT
SORUNUZ

YANGIN ALGILAMA VE
UYARI SİSTEMLERİ

138

 **DMY**
ELEKTRİK OTOMASYON AYDINLATMA

DMY Elektrik Otomasyon Aydınlatma San. ve Tic. A.Ş.
www.dmyea.com.tr















YANGIN SÖNDÜRME SİSTEMLERİ

FS5200E YANGIN SÖNDÜRME SİSTEMİ

- 3 Adet yangın alarm hattı
- 2 Adet yangın söndürme amaçlı alarm hattı
- 1 Adet yangın söndürme kontrolü olmayan alarm hattı
- RS485 Arayüz
- FS5200E Tekrarlama santrali ile uyumludur



YANGIN SÖNDÜRME SİSTEMLERİ

na·De®

KONVANSİYONEL

ÜRÜN KODU

ÜRÜN ADI

KOLİ AD.

FİYAT

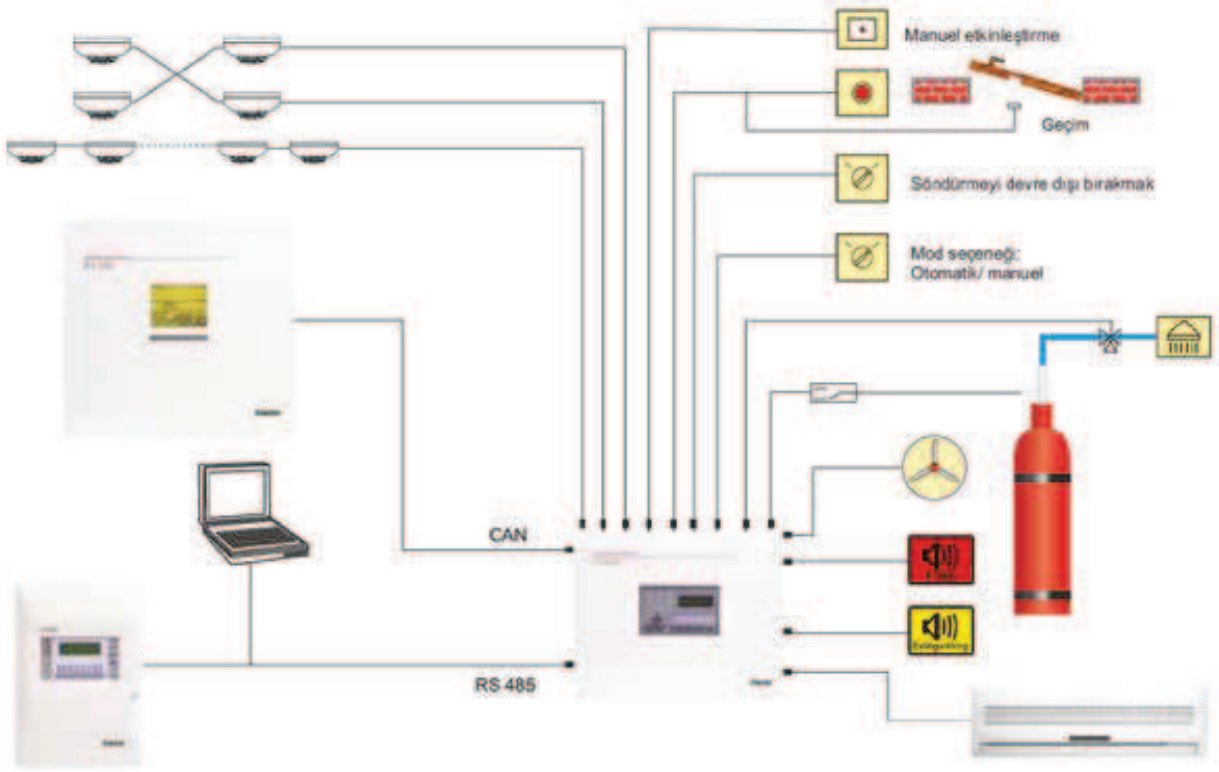

FS5200E_NADE

Yangın Söndürme Santrali

-

886,50 €

KONVANSİYONEL



FS5301_NADE

Yangın Söndürme Santrali Tekrarlama Modülü

-

272,80 €

KONVANSİYONEL

YANGIN ALGILAMA VE UYARI SİSTEMLERİ

YANGIN SÖNDÜRME SİSTEMLERİ

na·de®

KONVANSİYONEL

ÜRÜN KODU

ÜRÜN ADI

KOLİ AD.

FİYAT



FD3050Y_NADE

Serbest Bırakma Manuel Butonu

96

35,80 €

KONVANSİYONEL



FD3050G_NADE

Ek Serbest Bırakma Butonu

96

35,80 €

KONVANSİYONEL



FD3050B_NADE

Acil Stop Butonu

315

35,80 €

KONVANSİYONEL



FD5302_NADE

Rejim Seçim Anahtarı

-

40,20 €

KONVANSİYONEL

YANGIN ALGILAMA VE UYARI SİSTEMLERİ



DMY Elektrik Otomasyon Aydınlatma San. ve Tic. A.Ş.
www.dmyeo.com.tr



141



UNİPOS ADRESLİ YANGIN ALARM SİSTEMLERİ

- Adresleme cihazına ihtiyaç duyulmadan panel üzerinden otomatik adresleme
- Yangın ve arıza durumları (kısa devre, hat kopması vs.) için sürekli kontrol
- Printer opsiyonu ile olayları anlık yazdırılabilme
- Arttırılabilen Loop-Çevrim yapısı
- Her çevrim 210 adres kapasitesi
- Panelde 2.100 adres kapasitesi
- Network kablolama ile dağıtılmış yapıda çalışma özelliği
- Arıza durumu için ayırt edilebilir ses tonlu dahili buzzer
- Çoklu dil seçeneği
- Kontrol süresini tek tuşla uzatabilme özelliği
- TAHLİYE fonksiyonu ile tüm çıkışları aktif edebilme özelliği



- Gece / Gündüz çalışma modu özelliği
- Santral test modu özelliği
- Santral çevrimine bağlanabilen giriş/çıkış modülleri
- EN 54-2 ve EN 54-4 standartlarına uygunluk
- Çevrimdeki cihaz tipi ve parametrelerinin otomatik olarak algılanması
- Çevrimden sökülen cihazların algılanması
- Santral ve çevrim üzerindeki aygıtlar arasında iki yönlü bilgi alışverişi
- Gerçek zaman saati
- Elektromanyetik girişimlere karşı koruma
- Yüzey montaj teknolojisi ile üretim



ADRESLENEBİLİR

ÜRÜN KODU

ÜRÜN ADI

KOLİ AD.

FİYAT

YENİ



ADRESLENEBİLİR

7000M_UNIPOS

Adreslenebilir Yangın Alarm Paneli,
2x32 Bölge

6

FİYAT
SORUNUZ

YENİ



ADRESLENEBİLİR

7000M-P_UNIPOS

Adreslenebilir Yangın Alarm Paneli,
Printer, 32 Bölge

2

FİYAT
SORUNUZ

YENİ



ADRESLENEBİLİR

7000M BIO_UNIPOS

7000M BIO Modül (Giriş/Çıkış Modülü),
DIN Uyumlu

2

FİYAT
SORUNUZ

YENİ



ADRESLENEBİLİR

7000M LC_UNIPOS

7000M Loop Kartı, 2 Loop, 420 Adres,
DIN Uyumlu

6

FİYAT
SORUNUZ

YENİ



ADRESLENEBİLİR

7000M-R_UNIPOS

Adreslenebilir Tekrarlayıcı Panel

100

FİYAT
SORUNUZ



YANGIN ALGILAMA VE UYARI SİSTEMLERİ (7000M SERİSİ)

ADRESLENEBİLİR

ÜRÜN KODU

ÜRÜN ADI

KOLİ AD.

FİYAT

YENİ



ADRESLENEBİLİR

7000M-L_UNIPOS

Adreslenebilir Bölge Gösterge Paneli,
2x32 Bölge

100

FİYAT
SORUNUZ

YENİ



ADRESLENEBİLİR

FD7120M_UNIPOS

Adreslenebilir Isı Artış Dedektörü, İzolatörlü

100

FİYAT
SORUNUZ

YENİ



ADRESLENEBİLİR

FD7130M_UNIPOS

Adreslenebilir Optik Duman Dedektörü,
İzolatörlü

100

FİYAT
SORUNUZ

YENİ



ADRESLENEBİLİR

FD7160M_UNIPOS

Adreslenebilir Kombine Dedektörü, İzolatörlü

100

FİYAT
SORUNUZ

YENİ



ADRESLENEBİLİR

FD7150M_UNIPOS

Adreslenebilir Yangın Alarm Butonu, İzolatörlü

100

FİYAT
SORUNUZ

YANGIN ALGILAMA VE
UYARI SİSTEMLERİ

ADRESLENEBİLİR

ÜRÜN KODU

ÜRÜN ADI

KOLİ AD.

FİYAT



ADRESLENEBİLİR

71CNG_UNIPOS

Adreslenebilir Gaz Dedektörü_Nade (TypA)

6

55,6 €

*** 24V DC Harici Besleme Gereklidir

YENİ

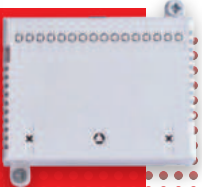

ADRESLENEBİLİR

FD7203M_UNIPOS

Adreslenebilir Harici 1 Grş/1 Çkş Modl, İzolatörlü

2

FİYAT
SORUNUZ

YENİ



ADRESLENEBİLİR

FD7206M_UNIPOS

Adreslenebilir Flaşörlü Siren, İzolatörlü

2

FİYAT
SORUNUZ

YENİ



ADRESLENEBİLİR

FD7205M_UNIPOS

Dahili Sirenli Dedektör Tabanı

6

FİYAT
SORUNUZ



ADRESLENEBİLİR

DB7100_UNIPOS

Dedektör Tabanı_UNIPOS

100

4,8 €



YANGIN ALGILAMA VE UYARI SİSTEMLERİ (7000M SERİSİ)

ADRESLENEBİLİR

ÜRÜN KODU

ÜRÜN ADI

KOLİ AD.

FİYAT

YENİ

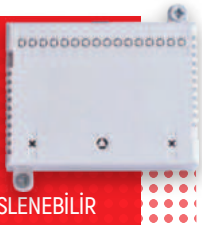

ADRESLENEBİLİR

FD7201M_UNIPOS

Konvansiyonel Sistemi Adresleme Adaptörü

100

FİYAT
SORUNUZ

ADRESLENEBİLİR - KONVANSİYONEL (HİBRİT)

YENİ



ADRESLENEBİLİR

7000-1MC_UNIPOS

7000-1mc Adreslenebilir / Konvansiyonel Hibrit Yangın Algılama Paneli

100

FİYAT
SORUNUZ

YENİ



ADRESLENEBİLİR

7000-1MC-8CL_UNIPOS 7000-1MC Konvansiyonel Bölge Kartı (8 Bölge)

100

FİYAT
SORUNUZ

YENİ



ADRESLENEBİLİR

7000-1MC-BIO_UNIPOS 7000-1MC Bio Modül (Giriş/Çıkış Modülü), DIN Uyumlu

100

FİYAT
SORUNUZ

*** 24V DC Harici Besleme Gereklidir

YANGIN ALGILAMA VE UYARI SİSTEMLERİ

146



DMY Elektrik Otomasyon Aydınlatma San. ve Tic. A.Ş.
www.dmyeoa.com.tr





YANGIN ALGILAMA VE UYARI SİSTEMLERİ (IFS7002 SERİSİ)

ADRESLENEBİLİR

ÜRÜN KODU

ÜRÜN ADI

KOLİ AD.

FİYAT



ADRESLENEBİLİR

IFS7002_UNIPOS

1 Çevrim (Loop) Yangın Alarm Santrali

6

909,20 €



ADRESLENEBİLİR

IFS7002/2_UNIPOS

2 Çevrim (Loop) Yangın Alarm Santrali

2

1633,60 €



ADRESLENEBİLİR

IFS7002/4_UNIPOS

4 Çevrim (Loop) Yangın Alarm Santrali

2

2.031,40 €



ADRESLENEBİLİR

IFS7002R_UNIPOS

Tekrarlama Santrali

6

909,20 €



ADRESLENEBİLİR

FD7110_UNIPOS

Sabit Isı Dedektörü

100

35,70 €

YANGIN ALGILAMA VE UYARI SİSTEMLERİ



DMY Elektrik Otomasyon Aydınlatma San. ve Tic. A.Ş.
www.dmyea.com.tr



147

ADRESLENEBİLİR

ÜRÜN KODU

ÜRÜN ADI

KOLİ AD.

FİYAT



ADRESLENEBİLİR

FD7120_UNIPOS

Sabit Isı ve Isı Artış Dedektörü

100

35,90 €



ADRESLENEBİLİR

FD7130_UNIPOS

Optik Duman Dedektörü

100

39,30 €



ADRESLENEBİLİR

FD7160_UNIPOS

Kombine (Duman ve Isı) Dedektörü

100

48,70 €



ADRESLENEBİLİR

FD7150_UNIPOS

Yangın Alarm Butonu

100

41,20 €



ADRESLENEBİLİR

FD71CNG_UNIPOS

Gaz Dedektörü (Metan)

100

55,60 €

*** 24V DC Harici Besleme Gereklidir



YANGIN ALGILAMA VE UYARI SİSTEMLERİ (IFS7002 SERİSİ)

ADRESLENEBİLİR

ÜRÜN KODU

ÜRÜN ADI

KOLİ AD.

FİYAT



ADRESLENEBİLİR

FD7203 10/16_UNIPOS 10 Giriş - 16 Çıkış Modül

100

284,20 €

*** 24V DC Harici Besleme Gereklidir



ADRESLENEBİLİR

FD7203 3/6_UNIPOS 3 Giriş - 6 Çıkış Modül

100

142,10 €

*** 24V DC Harici Besleme Gereklidir

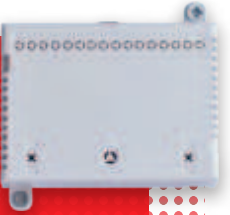

ADRESLENEBİLİR

FD7203_UNIPOS 1 Giriş - 1 Çıkış Modülü

100

164,80 €

FD7201SA_UNIPOS Konvansiyonel Sistemi Adresleme Adaptörü (Harici Beslemeli)

-

62,60 €

*** 24V DC Harici Besleme Gereklidir



ADRESLENEBİLİR



ADRESLENEBİLİR

FD7201S_UNIPOS Konvansiyonel Sistemi Adresleme Adaptörü

-

53,20 €

*** 1 Çevrime Maksimum 5 Adet Bağlanır



DMY Elektrik Otomasyon Aydınlatma San. ve Tic. A.Ş.
www.dmyea.com.tr



149

YANGIN ALGILAMA VE UYARI SİSTEMLERİ

ADRESLENEBİLİR

ÜRÜN KODU

ÜRÜN ADI

KOLİ AD.

FİYAT

YENİ



ADRESLENEBİLİR

FD7205M_UNIPOS

Dahili Sirenli Dedektör Tabanı

6

FİYAT SORUNUZ



ADRESLENEBİLİR

FD7204D_UNIPOS

Adreslenebilir Dahili Siren + Uyarı Işığı

-

61,90 €



ADRESLENEBİLİR

DB7100A_UNIPOS

FD7201S İçin Taban

-

14,30 €



ADRESLENEBİLİR

DB7100_UNIPOS

Standart Taban

315

4,80 €

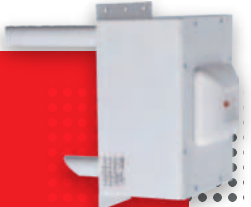

ADRESLENEBİLİR

YKB02A_UNIPOS

Kanal Tipi Duman Dedektörü

315

184,00 €



ADRESLENEBİLİR

RS-LAN_UNIPOS

RS-LAN Arayüz Modülü

-

355,20 €



YANGIN ALGILAMA VE UYARI SİSTEMLERİ

KONVANSİYONEL

ÜRÜN KODU

ÜRÜN ADI

KOLİ AD.

FİYAT

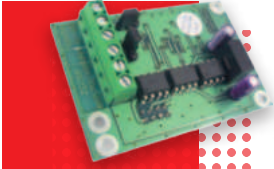

ADRESLENEBİLİR

RS 232/485_UNIPOS

Arayüz Modülü

-

112,70 €

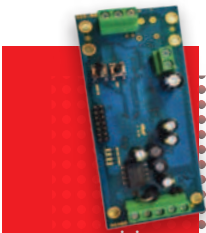

ADRESLENEBİLİR

MODBUS RTU_UNIPOS

BMS Modülü

-

513,80 €



KONVANSİYONEL

FS4000/2_UNIPOS

2 Bölge Yangın Alarm Santrali

6

193,20 €

FS4000/4_UNIPOS

4 Bölge Yangın Alarm Santrali

6

213,10 €

FS4000/6_UNIPOS

6 Bölge Yangın Alarm Santrali

6

255,70 €

FS4000/8_UNIPOS

8 Bölge Yangın Alarm Santrali

6

278,50 €

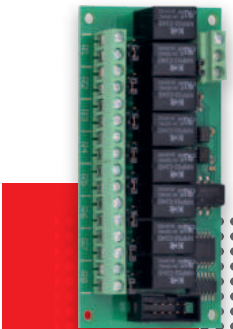

KONVANSİYONEL

FD4201/2_UNIPOS

FS4000 Seri Genişleme Modülü
(Bölgesel 2 Röle Çıkışı)

-

61,80 €

FD4201/4_UNIPOS

FS4000 Seri Genişleme Modülü
(Bölgesel 4 Röle Çıkışı)

-

147,00 €

FD4201/6_UNIPOS

FS4000 Seri Genişleme Modülü
(Bölgesel 6 Röle Çıkışı)

-

86,80 €

FD4201/8 (V1)_UNIPOS

FS4000 Seri Genişleme Modülü
(Bölgesel 8 Röle Çıkışı)

-

138,00 €

FD4201/8 (V2)_UNIPOS

FS4000 Seri Genişleme Modülü
(Bölgesel 8 Röle Çıkışı)

-

138,40 €

YANGIN ALGILAMA VE UYARI SİSTEMLERİ



Dedal
EVPU

DMY Elektrik Otomasyon Aydınlatma San. ve Tic. A.Ş.
www.dmyea.com.tr



151



YANGIN ALGILAMA VE UYARI SİSTEMLERİ

KONVANSİYONEL

ÜRÜN KODU

ÜRÜN ADI

KOLİ AD.

FİYAT



KONVANSİYONEL

FS5100_UNIPOS

2 Bölge Yangın Alarm Santrali

-

951,80 €

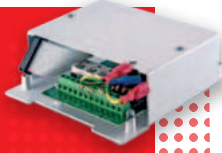

KONVANSİYONEL

5101_UNIPOS

FS5100 Serisi Genişleme Modülü
(3 Bölge + 3 Role)

315

198,90 €



KONVANSİYONEL

5102_UNIPOS

FS5100 Serisi Genişleme Modülü
(6 Bölge + 3 Role)

-

213,10 €



KONVANSİYONEL

FS5200_UNIPOS

8 Bölge Yangın Alarm Santrali

-

994,40 €



KONVANSİYONEL

5201_UNIPOS

FS5200 Serisi Genişleme Modülü (8 Bölge)

315

282,10 €

YANGIN ALGILAMA VE
UYARI SİSTEMLERİ

KONVANSİYONEL

ÜRÜN KODU

ÜRÜN ADI

KOLİ AD.

FİYAT



KONVANSİYONEL

5202_UNIPOS

FS5200 Serisi Genişleme Modülü
(8 Bölge + 1 Siren)

-

282,10 €

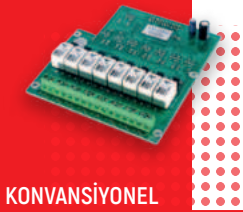

KONVANSİYONEL

5203_UNIPOS

FS5200 Serisi Genişleme Modülü (8 Röle)

-

172,80 €

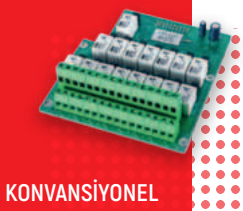

KONVANSİYONEL

5204_UNIPOS

FS5200 Serisi Genişleme Modülü (16 Röle)

-

381,10 €



KONVANSİYONEL

FS5200R_UNIPOS

Tekrarlama Paneli

-

710,30 €



YANGIN ALGILAMA VE UYARI SİSTEMLERİ

KONVANSİYONEL



KONVANSİYONEL

FD8010_UNIPOS

Sabit Isı Dedektörü

100

22,50 €



KONVANSİYONEL

FD8020_UNIPOS

Isı Artış Dedektörü

100

22,50 €



KONVANSİYONEL

FD8030_UNIPOS

Optik Duman Dedektörü

100

23,60 €



KONVANSİYONEL

FD8060_UNIPOS

Kombine [Optik Duman + Isı] Dedektörü

100

29,30 €



KONVANSİYONEL

FD8040_UNIPOS

Nokta Tipi Alev Dedektörü

100

71,10 €

KONVANSİYONEL

ÜRÜN KODU

ÜRÜN ADI

KOLİ AD.

FİYAT



KONVANSİYONEL

YKB02K_UNIPOS

Kanal Tipi Duman Dedektörü

198,90 €



KONVANSİYONEL

DB8000_UNIPOS

Standart Taban

315

4,30 €



KONVANSİYONEL

FD3050_UNIPOS

Yangın Algılama Butonu

96

25,90 €

YENİ



KONVANSİYONEL

FD7205_UNIPOS

Dahili Sirenli Dedektör Tabanı

FİYAT SORUNUZ



KONVANSİYONEL

FD8204CS_UNIPOS

Dahili Siren

96

30,20 €



KONVANSİYONEL

SB112F_UNIPOS

Harici Siren

-

71,10 €



YANGIN ALGILAMA VE UYARI SİSTEMLERİ

KONVANSİYONEL

ÜRÜN KODU

ÜRÜN ADI

KOLİ AD.

FİYAT



KONVANSİYONEL

RI31_UNIPOS

Paralel İhbar Lambası

-

5,80 €



KONVANSİYONEL

RI31S_UNIPOS

Mesafe Ses Göstergesi (Buzzer)

-

10,20 €



INTELLECT
YAZILIM_UNIPOS

Intellect Bilgisayarlı İzleme Yazılımı

-

1.428,90 €

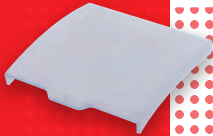

KONVANSİYONEL

TK_UNIPOS

FD7150 ve FD3050 Serisi İçin Plastik Şeffaf Kapak

50

2,30 €



KONVANSİYONEL

FS5200P_UNIPOS

Anahtarlamalı Güç Kaynağı

-

397,80 €

KONVANSİYONEL

ÜRÜN KODU

ÜRÜN ADI

KOLİ AD.

FİYAT



KONVANSİYONEL

AC8001_UNIPOS

Sıva Üstü Montaj Aparatı

-

2,30 €



KONVANSİYONEL

AC8002_UNIPOS

Nemli Ortam Sıva Üstü Montaj Aparatı

-

12,30 €



KONVANSİYONEL

DB8000R_UNIPOS

Röleli Dedektör Tabanı

315

14,30 €



KONVANSİYONEL

FS5200E_UNIPOS

Yangın Söndürme Santrali

-

923,40 €



KONVANSİYONEL

FD5301_UNIPOS

Yangın Söndürme Santrali Tekrarlama Modülü

-

284,20 €

KONVANSİYONEL

ÜRÜN KODU

ÜRÜN ADI

KOLİ AD.

FİYAT



KONVANSİYONEL

FD3050Y_UNIPOS

Serbest Bırakma Manuel Butonu

96

37,30 €



KONVANSİYONEL

FD3050G_UNIPOS

Ek Serbest Bırakma Butonu

96

37,30 €



KONVANSİYONEL

FD3050B_UNIPOS

Acil Stop Butonu

315

37,30 €



KONVANSİYONEL

FD5302_UNIPOS

Rejim Seçim Anahtarı

315

41,80 €

NOTLAR:

2024

NOTLAR:

NOTLAR:

NOTLAR:

NOTLAR:

2024

NOTLAR:

NOTLAR:

NOTLAR:

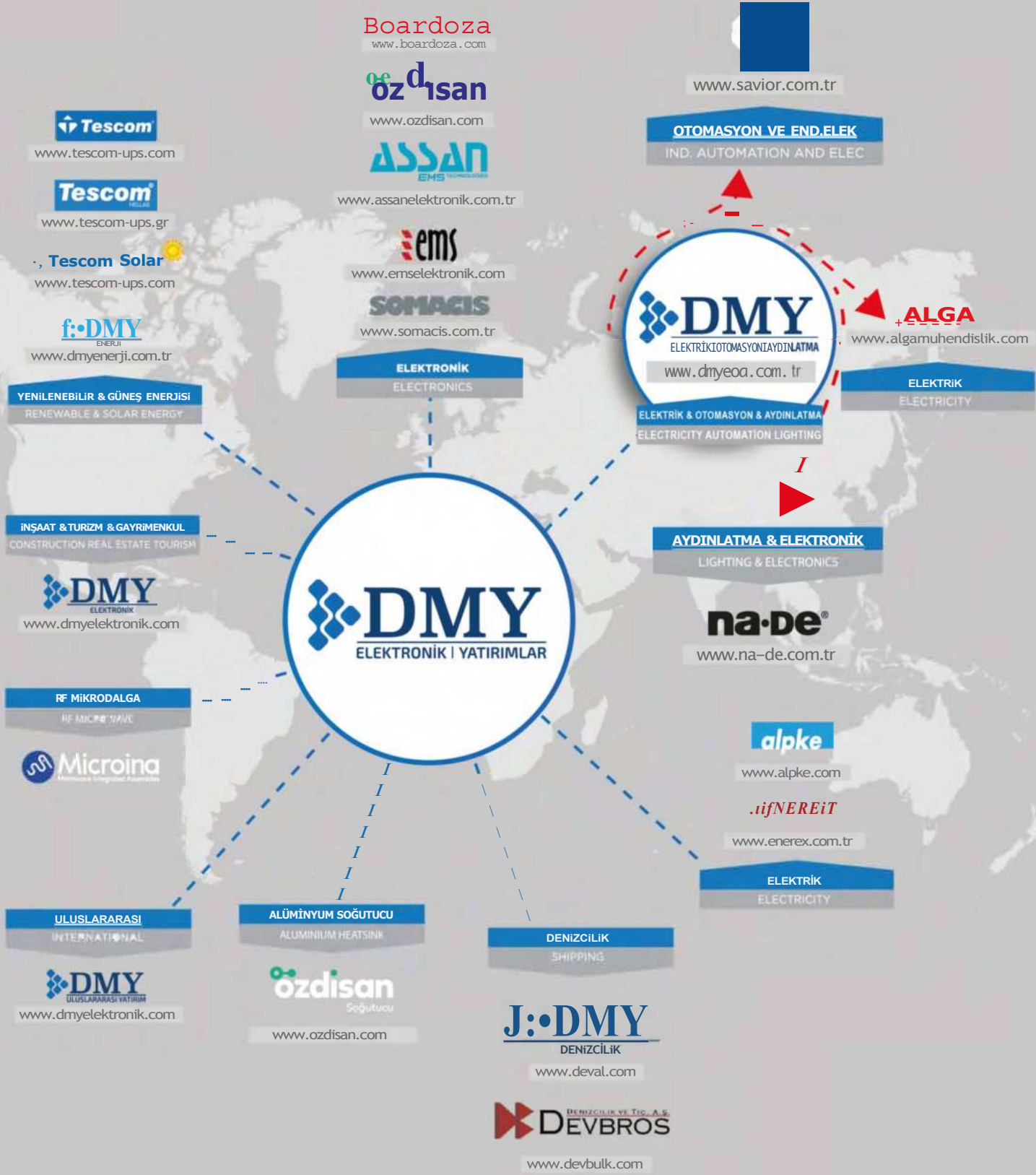

"Hayatın Her Alanında"

Türkiye

DMY EOA, DMY Elektronik Yatırımlar Grup Şirketidir.
www.dmyeoa.com.tr

na·De[®]



444 6 233

DMY
ELEKTRİK | OTOMASYON | AYDINLATMA

ALGA SAVIOR na·De

AKILLI ÇÖZÜMLER
DİJİTAL YENİLİKLER

DMY EOA, DMY Elektronik Yatırımlar Grup Şirketidir.

Emek Mah. Ordu Cad. No: 49/51, 34785
Sancaktepe/İSTANBUL - TÜRKİYE

info@dmyeoa.com.tr
www.dmyeoa.com.tr

0216 394 01 55 - 0216 394 01 56
0216 394 05 30 - 0216 394 01 98
0216 394 25 73 - 0216 394 01 64

KARAKÖY ŞUBE : 0212 244 45 02
BURSA ŞUBE : 0224 443 26 50
İZMİR ŞUBE : 0232 459 51 50
ANKARA ŞUBE : 0312 395 03 69

DMY EOA, DMY Elektronik Yatırımlar Grup Şirketidir.

