

FİYAT LİSTESİ 2024-2



içindekiler

anahtar priz grubu

YENİ Araç Şarj Cihazları	2
YENİ Şalt Ürünleri	4
YENİ Modüler Sistem	22
Rita Serisi	29
Elitra Plus Serisi	34
Candela Serisi	39
YENİ Bella Serisi	45
YENİ Nora Serisi	47
Bron Serisi	49
Grup priz ve Aksesuarlar	51

kablo kanalları, plastik, tesisat ve aydınlatma grubu

Canalex serisi kapalı tip kablo kanalları	61
Eko serisi kapalı tip kablo kanalları	61
Yapışkan bantlı kapalı tip kablo kanalları	61
Meks serisi kapalı tip kablo kanalları	62
Meks serisi klima kanalı ve aksesuarları	62
Tavan köşe ve süpürgelik kablo kanalları	62
Fugalı ve tezgah süpürgeliği	62
Balık sırtı zemin kanalları	62
H.Free Flaret kanal ve aksesuarları	63
Kanal aksesuarları	64
Meks plus serisi için priz setleri	66
Kanal için ups ve enerji prizleri 45x45	67
Kablo toplama spirali ve kablo omurga kanalı	70
Sidem serisi renkli kablo kanalları	71
Sidem serisi süpürgelikler ve aksesuarları	71
Comfort W otomat kutuları	75
Comfort zayıf akım kutuları	75
Meksbox W otomat kutuları	76
H. Free spiraller	77
Plastik spiraller	78
Hdpe koruge borular	78
Logar kutuları	78
Eko serisi çelik ve izole kaplı spiraller	79
Meks serisi çelik ve izole kaplı spiraller	79
Metal rakorlar	80
Pvc boy borular ve aksesuarları	81
Fiber kılavuz, çelik susta ve plastik sustalar	81
H.Free borular	82
PVC Boru aksesuarlar	83
Eko Serisi borular	84
Kalın boy boru ve dirsek-muflar	85
Poliyeten yeraltı boruları	85
Kasa, buat ve kapakları	86
Buatlar, çivili kroşeler	87

Dübeller, kroşeler, toplama çubuğu	88
YENİ Elektrik izolasyon bandı	89
Kapı otomatığı, trafolar, ziller ve butonları	91
Telefon dağıtım kutu ve aksesuarları	91
Ledli flaşör lambaları ve motorlu sirenler	92
YENİ ME-FAN aspiratörler	93
Mutlusan aspiratörler	94
Led armatür ve armatür çeşitleri	95
YENİ Aplikler	100
YENİ Solar bahçe aplikleri	102
Bahçe armatürleri	103
Exit - acil aydınlatma armatürleri	106

pano ve endüstriyel ürün grubu

Promex delikli kanallar	108
Delikli kablo kanalları	111
Promex Abs panoları ve otomat panoları	112
Pano prizleri	114
Abs pano aksesuarları	115
Higrostat ve termostatlar	116
Promex ve eko fan tepe fanları	118
Filtreli fanlar ve pano ısıtıcıları	120
R-Meks plastik kablo rakorları	122
Promex plastik kablo rakoru	123
Süper etanj plastik rakorlar	125
Polyamid spiral rakorları	125
YENİ UV Dayanımlı pano spiralleri, PP Spiraller	126
YENİ UV Kablo bağları, Mutlusan kablo bağları, yapışkan kroşeler	127
Ray klemensler ve dağıtım üniteleri	129
Geçmeli ve tırnaklı tip buat klemensler	131
Klemensler	131
YENİ Yüksükler	132
Baralar ve raylar	140
Skp çeşitleri	141
Sanayi tipi kauçuk fiş ve prizleri	142
Cee norm fiş ve prizler	144
Termoplastik buatlar ve kombinasyon kutuları	148
Kombinasyon panoları	150
Kumanda ve vinç kutuları	151
Butonlar ve potansiyometre	155
Ampermetre ve voltmetre	162
İkaz lambaları ve sirenler	164
Eko Serisi proje ürünleri	165

Mutlusan
CHARGEBOX

YENİ



Senin Enerjin
Senin Mutluluğun...



Kullanım Kılavuzu
İçin Lütfen Okutunuz

Tak Çalıştır (Plug&Play):

Kurulumu kolay ve hızlı, hemen şarj etmeye başlayın.

RFID Kimlik Doğrulaması:

Kişiselleştirilmiş güvenlik ve kullanım kolaylığı için akıllı doğrulama sistemi.

Modüler Elektronik Donanım Tasarımı:

Gelecekteki bakım ihtiyaçlarınıza uyum sağlamak için esnek ve yükseltilebilir yapı.

Mutlusan Chargebox ile elektrikli aracınız için güvenli, hızlı ve kolay bir şarj deneyimi yaşayın.

Chargebox V EV Charge



Portable EV Charge



ChargeBox Smart



yakında...

B TİPİ OTOMATİK SİGORTALAR - 6kA



MTS06 SERİSİ

Kutup Sayısı	In (A) Anma Akımı	Ürün Kodu	Kutu Adedi	Koli Adedi	Fiyat (\$)
1P	1A	MTS06-1001B	12	240	5,03 \$
	2A	MTS06-1002B	12	240	5,03 \$
	3A	MTS06-1003B	12	240	5,03 \$
	4A	MTS06-1004B	12	240	5,03 \$
	5A	MTS06-1005B	12	240	5,03 \$
	6A	MTS06-1006B	12	240	4,14 \$
	10A	MTS06-1010B	12	240	3,45 \$
	16A	MTS06-1016B	12	240	3,45 \$
	20A	MTS06-1020B	12	240	3,45 \$
	25A	MTS06-1025B	12	240	3,45 \$
	32A	MTS06-1032B	12	240	4,07 \$
	40A	MTS06-1040B	12	240	4,81 \$
	50A	MTS06-1050B	12	240	5,21 \$
	63A	MTS06-1063B	12	240	5,41 \$
2P	1A	MTS06-2001B	6	120	10,69 \$
	2A	MTS06-2002B	6	120	10,69 \$
	3A	MTS06-2003B	6	120	10,69 \$
	4A	MTS06-2004B	6	120	10,69 \$
	5A	MTS06-2005B	6	120	10,69 \$
	6A	MTS06-2006B	6	120	10,10 \$
	10A	MTS06-2010B	6	120	8,72 \$
	16A	MTS06-2016B	6	120	8,72 \$
	20A	MTS06-2020B	6	120	8,72 \$
	25A	MTS06-2025B	6	120	8,72 \$
	32A	MTS06-2032B	6	120	9,97 \$
	40A	MTS06-2040B	6	120	10,79 \$
	50A	MTS06-2050B	6	120	11,55 \$
	63A	MTS06-2063B	6	120	11,90 \$
3P	1A	MTS06-3001B	4	80	16,18 \$
	2A	MTS06-3002B	4	80	16,18 \$
	3A	MTS06-3003B	4	80	16,18 \$
	4A	MTS06-3004B	4	80	16,18 \$
	5A	MTS06-3005B	4	80	16,18 \$
	6A	MTS06-3006B	4	80	15,55 \$
	10A	MTS06-3010B	4	80	12,24 \$
	16A	MTS06-3016B	4	80	12,24 \$
	20A	MTS06-3020B	4	80	12,24 \$
	25A	MTS06-3025B	4	80	12,24 \$
	32A	MTS06-3032B	4	80	12,45 \$
	40A	MTS06-3040B	4	80	12,69 \$
	50A	MTS06-3050B	4	80	16,90 \$
	63A	MTS06-3063B	4	80	18,28 \$
4P	1A	MTS06-4001B	3	60	23,05 \$
	2A	MTS06-4002B	3	60	23,05 \$
	3A	MTS06-4003B	3	60	23,05 \$
	4A	MTS06-4004B	3	60	23,05 \$
	5A	MTS06-4005B	3	60	23,05 \$
	6A	MTS06-4006B	3	60	20,83 \$
	10A	MTS06-4010B	3	60	16,79 \$
	16A	MTS06-4016B	3	60	16,79 \$
	20A	MTS06-4020B	3	60	16,79 \$
	25A	MTS06-4025B	3	60	16,79 \$
	32A	MTS06-4032B	3	60	17,72 \$
	40A	MTS06-4040B	3	60	19,07 \$
	50A	MTS06-4050B	3	60	21,79 \$
	63A	MTS06-4063B	3	60	22,79 \$



TS E C E C TİPİ OTOMATİK SİGORTALAR - 6kA

MTS06 SERİSİ



Kutup Sayısı	In (A) Anma Akımı	Ürün Kodu	Kutu Adedi	Koli Adedi	Fiyat (\$)
1P	1A	MTS06-1001C	12	240	5,12 \$
	2A	MTS06-1002C	12	240	5,12 \$
	3A	MTS06-1003C	12	240	5,12 \$
	4A	MTS06-1004C	12	240	5,12 \$
	5A	MTS06-1005C	12	240	5,12 \$
	6A	MTS06-1006C	12	240	4,31 \$
	10A	MTS06-1010C	12	240	3,62 \$
	16A	MTS06-1016C	12	240	3,62 \$
	20A	MTS06-1020C	12	240	3,62 \$
	25A	MTS06-1025C	12	240	3,62 \$
	32A	MTS06-1032C	12	240	4,42 \$
	40A	MTS06-1040C	12	240	5,17 \$
	50A	MTS06-1050C	12	240	5,55 \$
63A	MTS06-1063C	12	240	5,85 \$	
2P	1A	MTS06-2001C	6	120	13,10 \$
	2A	MTS06-2002C	6	120	13,10 \$
	3A	MTS06-2003C	6	120	13,10 \$
	4A	MTS06-2004C	6	120	13,10 \$
	5A	MTS06-2005C	6	120	13,10 \$
	6A	MTS06-2006C	6	120	10,69 \$
	10A	MTS06-2010C	6	120	10,69 \$
	16A	MTS06-2016C	6	120	10,69 \$
	20A	MTS06-2020C	6	120	10,69 \$
	25A	MTS06-2025C	6	120	10,69 \$
	32A	MTS06-2032C	6	120	11,72 \$
	40A	MTS06-2040C	6	120	13,10 \$
	50A	MTS06-2050C	6	120	18,97 \$
63A	MTS06-2063C	6	120	19,48 \$	
3P	1A	MTS06-3001C	4	80	17,31 \$
	2A	MTS06-3002C	4	80	17,31 \$
	3A	MTS06-3003C	4	80	17,31 \$
	4A	MTS06-3004C	4	80	17,31 \$
	5A	MTS06-3005C	4	80	17,31 \$
	6A	MTS06-3006C	4	80	15,55 \$
	10A	MTS06-3010C	4	80	15,55 \$
	16A	MTS06-3016C	4	80	15,55 \$
	20A	MTS06-3020C	4	80	15,55 \$
	25A	MTS06-3025C	4	80	15,55 \$
	32A	MTS06-3032C	4	80	16,38 \$
	40A	MTS06-3040C	4	80	17,07 \$
	50A	MTS06-3050C	4	80	21,69 \$
63A	MTS06-3063C	4	80	27,41 \$	
4P	1A	MTS06-4001C	3	60	27,69 \$
	2A	MTS06-4002C	3	60	27,69 \$
	3A	MTS06-4003C	3	60	27,69 \$
	4A	MTS06-4004C	3	60	27,69 \$
	5A	MTS06-4005C	3	60	27,69 \$
	6A	MTS06-4006C	3	60	23,45 \$
	10A	MTS06-4010C	3	60	22,07 \$
	16A	MTS06-4016C	3	60	22,07 \$
	20A	MTS06-4020C	3	60	22,07 \$
	25A	MTS06-4025C	3	60	22,07 \$
	32A	MTS06-4032C	3	60	25,17 \$
	40A	MTS06-4040C	3	60	26,90 \$
	50A	MTS06-4050C	3	60	35,41 \$
63A	MTS06-4063C	3	60	38,34 \$	

C TİPİ OTOMATİK SİGORTALAR - 10kA



MTS10 SERİSİ

Kutup Sayısı	In (A) Anma Akımı	Ürün Kodu	Kutu Adedi	Koli Adedi	Fiyat (\$)
1P	1A	MTS10-1001C	12	240	8,62 \$
	2A	MTS10-1002C	12	240	8,62 \$
	3A	MTS10-1003C	12	240	8,62 \$
	4A	MTS10-1004C	12	240	8,62 \$
	5A	MTS10-1005C	12	240	8,62 \$
	6A	MTS10-1006C	12	240	7,03 \$
	10A	MTS10-1010C	12	240	6,52 \$
	16A	MTS10-1016C	12	240	6,52 \$
	20A	MTS10-1020C	12	240	6,52 \$
	25A	MTS10-1025C	12	240	6,52 \$
	32A	MTS10-1032C	12	240	6,69 \$
	40A	MTS10-1040C	12	240	7,62 \$
	50A	MTS10-1050C	12	240	7,93 \$
	63A	MTS10-1063C	12	240	10,00 \$
2P	1A	MTS10-2001C	6	120	21,38 \$
	2A	MTS10-2002C	6	120	21,38 \$
	3A	MTS10-2003C	6	120	21,38 \$
	4A	MTS10-2004C	6	120	21,38 \$
	5A	MTS10-2005C	6	120	21,38 \$
	6A	MTS10-2006C	6	120	21,45 \$
	10A	MTS10-2010C	6	120	17,48 \$
	16A	MTS10-2016C	6	120	17,48 \$
	20A	MTS10-2020C	6	120	17,48 \$
	25A	MTS10-2025C	6	120	17,48 \$
	32A	MTS10-2032C	6	120	20,72 \$
	40A	MTS10-2040C	6	120	21,10 \$
	50A	MTS10-2050C	6	120	24,86 \$
	63A	MTS10-2063C	6	120	25,24 \$
3P	1A	MTS10-3001C	4	80	28,59 \$
	2A	MTS10-3002C	4	80	28,59 \$
	3A	MTS10-3003C	4	80	28,59 \$
	4A	MTS10-3004C	4	80	28,59 \$
	5A	MTS10-3005C	4	80	28,59 \$
	6A	MTS10-3006C	4	80	23,07 \$
	10A	MTS10-3010C	4	80	20,72 \$
	16A	MTS10-3016C	4	80	20,72 \$
	20A	MTS10-3020C	4	80	20,72 \$
	25A	MTS10-3025C	4	80	22,62 \$
	32A	MTS10-3032C	4	80	23,24 \$
	40A	MTS10-3040C	4	80	25,07 \$
	50A	MTS10-3050C	4	80	25,83 \$
	63A	MTS10-3063C	4	80	32,21 \$
4P	1A	MTS10-4001C	3	60	38,34 \$
	2A	MTS10-4002C	3	60	38,34 \$
	3A	MTS10-4003C	3	60	38,34 \$
	4A	MTS10-4004C	3	60	38,34 \$
	5A	MTS10-4005C	3	60	38,34 \$
	6A	MTS10-4006C	3	60	32,34 \$
	10A	MTS10-4010C	3	60	30,45 \$
	16A	MTS10-4016C	3	60	30,45 \$
	20A	MTS10-4020C	3	60	30,45 \$
	25A	MTS10-4025C	3	60	30,79 \$
	32A	MTS10-4032C	3	60	30,79 \$
	40A	MTS10-4040C	3	60	31,86 \$
	50A	MTS10-4050C	3	60	45,28 \$
	63A	MTS10-4063C	3	60	51,62 \$



C TİPİ OTOMATİK SİGORTALAR - 10kA

MTS SERİSİ



Kutup Sayısı	In (A) Anma Akımı	Ürün Kodu	Kutu Adedi	Koli Adedi	Fiyat (\$)
1P	80A	MTS10-1080C	12	240	19,31 \$
	100A	MTS10-1100C	12	240	19,97 \$
	125A	MTS10-1125C	12	240	22,90 \$
2P	80A	MTS10-2080C	6	120	35,59 \$
	100A	MTS10-2100C	6	120	38,41 \$
	125A	MTS10-2125C	6	120	42,66 \$
3P	80A	MTS10-3080C	4	80	68,03 \$
	100A	MTS10-3100C	4	80	70,07 \$
	125A	MTS10-3125C	4	80	76,34 \$
4P	80A	MTS10-4080C	3	60	92,76 \$
	100A	MTS10-4100C	3	60	95,93 \$
	125A	MTS10-4125C	3	60	131,41 \$

OTOMATİK SİGORTA YARDIMCI KONTAKLARI

Ürün Kodu	Ürün Adı	Kutu Adedi	Koli Adedi	Fiyat (\$)
MTSAUX-AC12	1NO+1NC 160 - 250A Yardımcı Kontak	30	720	9,83 \$
MTSAUX-DC12	2NO+2NC 160 - 250A Yardımcı Kontak	30	540	9,83 \$

FAZ+NÖTR SİGORTALAR - 4,5kA

MTS04-N SERİSİ



Kutup Sayısı	In (A) Anma Akımı	Ürün Kodu	Kutu Adedi	Koli Adedi	Fiyat (\$)
1P+N	6A	MTS04-106CN	12	240	4,69 \$
	10A	MTS04-110CN	12	240	3,90 \$
	16A	MTS04-116CN	12	240	3,90 \$
	20A	MTS04-120CN	12	240	3,90 \$
	25A	MTS04-125CN	12	240	3,90 \$
	32A	MTS04-132CN	12	240	4,50 \$
	40A	MTS04-140CN	12	240	5,00 \$

KAÇAK AKIM DEVRE KESİCİLER 6kA / AC



MRC06 SERİSİ

Kutup Sayısı	In (A) Anma Akımı	mA	Ürün Kodu	Kutu Adedi	Koli Adedi	Fiyat (\$)
2P	16A	10 mA	MRC06-201016	1	100	26,38 \$
	25A		MRC06-201025	1	100	26,90 \$
	16A	30 mA	MRC06-203016	1	100	26,38 \$
	20A		MRC06-203020	1	100	26,90 \$
	25A		MRC06-203025	1	100	26,90 \$
	32A		MRC06-203032	1	100	27,24 \$
	40A		MRC06-203040	1	100	27,55 \$
	50A		MRC06-203050	1	100	29,31 \$
	63A		MRC06-203063	1	100	29,31 \$
	80A		MRC06-203080	1	100	40,33 \$
	100A		MRC06-2030100	1	100	48,28 \$
	16A		100 mA	MRC06-210016	1	100
	20A	MRC06-210020		1	100	26,90 \$
	25A	MRC06-210025		1	100	26,90 \$
	32A	MRC06-210032		1	100	27,24 \$
	40A	MRC06-210040		1	100	27,55 \$
	50A	MRC06-210050		1	100	29,31 \$
	63A	MRC06-210063		1	100	29,31 \$
	80A	MRC06-210080		1	100	40,33 \$
	100A	MRC06-2100100		1	100	48,28 \$
	16A	300 mA		MRC06-230016	1	100
	20A		MRC06-230020	1	100	26,45 \$
	25A		MRC06-230025	1	100	26,45 \$
	32A		MRC06-230032	1	100	26,45 \$
	40A		MRC06-230040	1	100	26,45 \$
	50A		MRC06-230050	1	100	28,90 \$
	63A		MRC06-230063	1	100	29,38 \$
	80A		MRC06-230080	1	100	39,62 \$
100A	MRC06-2300100		1	100	44,49 \$	
4P	16A		30 mA	MRC06-403016	1	50
	20A	MRC06-403020		1	50	36,17 \$
	25A	MRC06-403025		1	50	36,17 \$
	32A	MRC06-403032		1	50	36,86 \$
	40A	MRC06-403040		1	50	37,90 \$
	50A	MRC06-403050		1	50	37,90 \$
	63A	MRC06-403063		1	50	39,72 \$
	80A	MRC06-403080		1	50	41,21 \$
	100A	MRC06-4030100		1	50	44,83 \$
	16A	100 mA		MRC06-410016	1	50
	20A		MRC06-410020	1	50	36,17 \$
	25A		MRC06-410025	1	50	36,17 \$
	32A		MRC06-410032	1	50	36,86 \$
	40A		MRC06-410040	1	50	37,90 \$
	50A		MRC06-410050	1	50	37,90 \$
	63A		MRC06-410063	1	50	39,72 \$
	80A		MRC06-410080	1	50	41,21 \$
	100A		MRC06-4100100	1	50	44,83 \$
	16A		300 mA	MRC06-430016	1	50
	20A	MRC06-430020		1	50	34,55 \$
	25A	MRC06-430025		1	50	34,55 \$
	32A	MRC06-430032		1	50	34,55 \$
	40A	MRC06-430040		1	50	36,45 \$
	50A	MRC06-430050		1	50	38,14 \$
	63A	MRC06-430063		1	50	40,38 \$
	80A	MRC06-430080		1	50	57,67 \$
	100A	MRC06-4300100		1	50	64,83 \$



KOMPAKT TİP DEVRE KESİCİLER - TERMİK MANYETİK - SABİT TİP

MTF SERİSİ



Kutup Sayısı	In (A) Anma Akımı	kA	Ürün Kodu	Kutu Adedi	Koli Adedi	Fiyat (\$)	
2P	40A	18 kA	MTF18-2040	1	36	76,48 \$	
	63A		MTF18-2063	1	36	79,66 \$	
	100A		MTF18-2100	1	36	79,66 \$	
	125A		MTF18-2125	1	36	79,66 \$	
	160A		MTF18-2160	1	36	82,90 \$	
3P	16A	22 kA	MTF22-3016	1	24	82,65 \$	
	40A		MTF22-3040	1	24	82,65 \$	
	63A		MTF22-3063	1	24	86,62 \$	
	100A		MTF22-3100	1	24	86,62 \$	
	125A		MTF22-3125	1	24	86,62 \$	
	160A		MTF22-3160	1	24	90,65 \$	
	16A	25 kA	MTF25-3016	1	24	84,48 \$	
	25A		MTF25-3025	1	24	84,48 \$	
	32A		MTF25-3032	1	24	84,48 \$	
	40A		MTF25-3040	1	24	84,48 \$	
	50A		MTF25-3050	1	24	84,48 \$	
	63A		MTF25-3063	1	24	84,48 \$	
	80A		MTF25-3080	1	24	84,48 \$	
	100A		MTF25-3100	1	24	91,10 \$	
	125A		MTF25-3125	1	24	91,10 \$	
	160A		MTF25-3160	1	24	91,10 \$	
	100A		35 kA	MTF35-3100	1	16	138,46 \$
	125A			MTF35-3125	1	16	138,46 \$
	160A	MTF35-3160		1	16	138,46 \$	
	200A	MTF35-3200		1	16	138,46 \$	
	250A	MTF35-3250		1	16	138,46 \$	
	100A	42 kA	MTF42-3100	1	16	161,11 \$	
	125A		MTF42-3125	1	16	161,11 \$	
	160A		MTF42-3160	1	16	161,11 \$	
	200A		MTF42-3200	1	16	161,11 \$	
	250A		MTF42-3250	1	16	161,11 \$	
	315A	50 kA	MTF50-30315	1	4	275,86 \$	
	400A		MTF50-30400	1	4	310,34 \$	
500A	MTF50-30500		1	2	344,83 \$		
630A	MTF50-30630		1	2	385,14 \$		
800A	MTF50-30800		1	2	898,66 \$		
4P	16A	22 kA	MTF22-4016	1	18	103,87 \$	
	40A		MTF22-4040	1	18	103,87 \$	
	63A		MTF22-4063	1	18	111,81 \$	
	100A		MTF22-4100	1	18	111,81 \$	
	125A		MTF22-4125	1	18	111,81 \$	
	160A		MTF22-4160	1	18	113,79 \$	
	16A	25 kA	MTF25-4016	1	18	119,66 \$	
	25A		MTF25-4025	1	18	119,66 \$	
	32A		MTF25-4032	1	18	119,66 \$	
	40A		MTF25-4040	1	18	119,66 \$	
	63A		MTF25-4063	1	18	119,66 \$	
	80A		MTF25-4080	1	18	125,52 \$	
	100A		MTF25-4100	1	18	129,13 \$	
	125A		MTF25-4125	1	18	134,44 \$	
	160A		MTF25-4160	1	18	140,16 \$	
	100A		35 kA	MTF35-4100	1	12	184,56 \$
	125A			MTF35-4125	1	12	184,56 \$
	160A			MTF35-4160	1	12	184,56 \$
	200A	MTF35-4200		1	12	184,56 \$	
	250A	MTF35-4250		1	12	184,56 \$	
	100A	42 kA	MTF42-4100	1	12	197,51 \$	
	125A		MTF42-4125	1	12	197,51 \$	
	160A		MTF42-4160	1	12	197,51 \$	
	200A		MTF42-4200	1	12	197,51 \$	
	250A		MTF42-4250	1	12	197,51 \$	
	315A	50 kA	MTF50-40315	1	3	482,76 \$	
	400A		MTF50-40400	1	3	517,24 \$	
	500A		MTF50-40500	1	2	641,90 \$	
630A	MTF50-40630		1	2	672,41 \$		
800A	MTF50-40800		1	2	1034,48 \$		

KOMPAKT TİP DEVRE KESİCİLER - TERMİK MANYETİK - AYAR SAHALI

Kutup Sayısı	In (A) Anma Akımı	kA	Ürün Kodu	Kutu Adedi	Koli Adedi	Fiyat (\$)
2P	40A	18 kA	MTA18-2040	1	36	115,44 \$
	63A		MTA18-2063	1	36	120,26 \$
	100A		MTA18-2100	1	36	123,28 \$
	125A		MTA18-2125	1	36	127,56 \$
	160A		MTA18-2160	1	36	136,62 \$
3P	16A	22 kA	MTA22-3016	1	24	140,87 \$
	40A		MTA22-3040	1	24	143,69 \$
	63A		MTA22-3063	1	24	150,73 \$
	100A		MTA22-3100	1	24	151,61 \$
	125A		MTA22-3125	1	24	152,52 \$
	160A		MTA22-3160	1	24	157,77 \$
	16A	25 kA	MTA25-3016	1	24	170,01 \$
	25A		MTA25-3025	1	24	170,01 \$
	32A		MTA25-3032	1	24	170,01 \$
	40A		MTA25-3040	1	24	174,87 \$
	50A		MTA25-3050	1	24	174,86 \$
	63A		MTA25-3063	1	24	187,13 \$
	80A		MTA25-3080	1	24	187,13 \$
	100A		MTA25-3100	1	24	193,59 \$
	125A		MTA25-3125	1	24	199,35 \$
	160A		MTA25-3160	1	24	204,83 \$
	100A	35 kA	MTA35-3100	1	16	122,03 \$
	125A		MTA35-3125	1	16	155,26 \$
	160A		MTA35-3160	1	16	161,47 \$
	200A		MTA35-3200	1	16	196,69 \$
	250A		MTA35-3250	1	16	205,90 \$
	100A	42 kA	MTA42-3100	1	16	150,00 \$
	125A		MTA42-3125	1	16	153,79 \$
	160A		MTA42-3160	1	16	157,48 \$
	200A		MTA42-3200	1	16	188,14 \$
	250A		MTA42-3250	1	16	195,86 \$
	315A	50 kA	MTA50-30315	1	4	379,31 \$
	400A		MTA50-30400	1	4	518,07 \$
	630A		MTA50-30630	1	2	631,59 \$
800A	MTA50-30800		1	2	800,24 \$	
4P	16A	22 kA	MTA22-4016	1	18	189,59 \$
	40A		MTA22-4040	1	18	193,33 \$
	63A		MTA22-4063	1	18	199,45 \$
	100A		MTA22-4100	1	18	202,40 \$
	125A		MTA22-4125	1	18	206,14 \$
	160A		MTA22-4160	1	18	208,24 \$
	16A	25 kA	MTA25-4016	1	18	213,89 \$
	25A		MTA25-4025	1	18	213,89 \$
	32A		MTA25-4032	1	18	213,89 \$
	40A		MTA25-4040	1	18	219,61 \$
	63A		MTA25-4063	1	18	229,03 \$
	80A		MTA25-4080	1	18	235,03 \$
	100A		MTA25-4100	1	18	235,03 \$
	125A		MTA25-4125	1	18	239,53 \$
	160A		MTA25-4160	1	18	246,97 \$
	100A		35 kA	MTA35-4100	1	12
	125A	MTA35-4125		1	12	255,34 \$
	160A	MTA35-4160		1	12	273,06 \$
	200A	MTA35-4200		1	12	320,31 \$
	250A	MTA35-4250		1	12	343,91 \$
	100A	42 kA	MTA42-4100	1	12	221,17 \$
	125A		MTA42-4125	1	12	247,59 \$
	160A		MTA42-4160	1	12	307,48 \$
	200A		MTA42-4200	1	12	332,59 \$
	250A		MTA42-4250	1	12	355,66 \$
	315A	50 kA	MTA50-40315	1	3	724,14 \$
	400A		MTA50-40400	1	3	760,69 \$
	630A		MTA50-40630	1	2	840,00 \$
	800A		MTA50-40800	1	2	1614,52 \$

MTA SERİSİ



KOMPAKT TİP DEVRE KESİCİLER - TERMİK MANYETİK - KAÇAK AKIMLI

MTL SERİSİ



Kutup Sayısı	In (A) Anma Akımı	kA	Ürün Kodu	Kutu Adedi	Koli Adedi	Fiyat (\$)
2P	40A	18 kA	MTL18-2025	1	36	258,62 \$
	63A		MTL18-2040	1	36	265,52 \$
	100A		MTL18-2063	1	36	276,59 \$
	125A		MTL18-2100	1	36	283,53 \$
	160A		MTL18-2125	1	36	293,39 \$
3P	16A	22 kA	MTL22-3016	1	20	312,36 \$
	40A		MTL22-3040	1	20	316,55 \$
	63A		MTL22-3063	1	20	324,17 \$
	100A		MTL22-3100	1	20	326,98 \$
	125A		MTL22-3125	1	20	331,48 \$
	16A	25 kA	MTL25-3016	1	20	288,91 \$
	25A		MTL25-3025	1	20	288,91 \$
	32A		MTL25-3032	1	20	288,91 \$
	40A		MTL25-3040	1	20	300,71 \$
	50A		MTL25-3050	1	20	310,30 \$
	63A		MTL25-3063	1	20	310,30 \$
	80A		MTL25-3080	1	20	317,99 \$
	100A		MTL25-3100	1	20	317,99 \$
	125A		MTL25-3125	1	20	327,33 \$
	100A		35 kA	MTL35-3100	1	10
	125A	MTL35-3125		1	10	247,59 \$
	160A	MTL35-3160		1	10	258,97 \$
	200A	MTL35-3200		1	10	319,52 \$
	250A	MTL35-3250		1	10	338,34 \$
	100A	42 kA	MTL42-3100	1	10	344,58 \$
	125A		MTL42-3125	1	10	379,04 \$
	160A		MTL42-3160	1	10	396,27 \$
	200A		MTL42-3200	1	10	413,49 \$
	250A		MTL42-3250	1	10	430,72 \$
	315A	50 kA	MTL50-30315	1	4	694,32 \$
400A	MTL50-30400		1	4	694,32 \$	
630A	MTL50-30630		1	2	715,55 \$	
800A	MTL50-30800		1	2	1373,60 \$	
4P	16A	22 kA	MTL22-4016	1	16	344,65 \$
	40A		MTL22-4025	1	16	360,91 \$
	63A		MTL22-4040	1	16	360,91 \$
	100A		MTL22-4063	1	16	366,28 \$
	125A		MTL22-4100	1	16	373,76 \$
	160A	MTL22-4125	1	16	380,01 \$	
	16A	25 kA	MTL25-4016	1	16	348,83 \$
	25A		MTL25-4025	1	16	351,72 \$
	32A		MTL25-4032	1	16	351,72 \$
	40A		MTL25-4040	1	16	359,50 \$
	63A		MTL25-4050	1	16	373,69 \$
	80A		MTL25-4063	1	16	373,69 \$
	100A		MTL25-4080	1	16	381,28 \$
	125A		MTL25-4100	1	16	381,28 \$
	160A		MTL25-4125	1	16	389,00 \$
	100A		35 kA	MTL35-4100	1	8
	125A	MTL35-4125		1	8	284,45 \$
	160A	MTL35-4160		1	8	300,37 \$
	200A	MTL35-4200		1	8	372,54 \$
	250A	MTL35-4250		1	8	391,65 \$
	100A	42 kA	MTL42-4100	1	8	371,09 \$
	125A		MTL42-4125	1	8	408,20 \$
	160A		MTL42-4160	1	8	426,75 \$
	200A		MTL42-4200	1	8	445,31 \$
	250A		MTL42-4250	1	8	463,86 \$
315A	50 kA	MTL50-40315	1	3	874,75 \$	
400A		MTL50-40400	1	3	874,75 \$	
630A		MTL50-40630	1	2	902,17 \$	
800A		MTL50-40800	1	2	1739,78 \$	

AÇIK TİP DEVRE KESİCİLER - SABİT TİP

MTACF SERİSİ



Kutup Sayısı	In (A) Anma Akımı	kA	Ürün Kodu	Kutu Adedi	Koli Adedi	Fiyat (\$)
3P	1000A	65 kA	MTACF3-0651000	1	1	2.602,73 \$
	1250A		MTACF3-0651250	1	1	2.825,43 \$
	1600A		MTACF3-0651600	1	1	3.106,23 \$
	2000A		MTACF3-0652000	1	1	3.660,08 \$
	2500A		MTACF3-0652500	1	1	4.676,77 \$
	3200A		MTACF3-0653200	1	1	5.490,12 \$
	4000A	120 kA	MTACF3-1204000	1	1	13.460,06 \$
	5000A		MTACF3-1205000	1	1	23.981,12 \$
	6300A	MTACF3-1206300	1	1	27.070,22 \$	
4P	1000A	65 kA	MTACF4-0651000	1	1	3.863,42 \$
	1250A		MTACF4-0651250	1	1	4.066,76 \$
	1600A		MTACF4-0651600	1	1	4.371,77 \$
	2000A		MTACF4-0652000	1	1	4.575,10 \$
	2500A		MTACF4-0652500	1	1	5.896,80 \$
	3200A		MTACF4-0653200	1	1	6.913,49 \$
	4000A	120 kA	MTACF4-1204000	1	1	17.535,66 \$
	5000A		MTACF4-1205000	1	1	22.602,58 \$
	6300A	MTACF4-1206300	1	1	24.581,42 \$	

AÇIK TİP DEVRE KESİCİLER - ÇEKMECELİ TİP

MTACD SERİSİ



Kutup Sayısı	In (A) Anma Akımı	kA	Ürün Kodu	Kutu Adedi	Koli Adedi	Fiyat (\$)
3P	1000A	65 kA	MTACD3-0651000	1	1	3.290,45 \$
	1250A		MTACD3-0651250	1	1	3.290,45 \$
	1600A		MTACD3-0651600	1	1	3.718,18 \$
	2000A		MTACD3-0652000	1	1	4.447,29 \$
	2500A		MTACD3-0652500	1	1	5.694,43 \$
	3200A		MTACD3-0653200	1	1	6.470,99 \$
	4000A	120 kA	MTACD3-1204000	1	1	15.229,97 \$
	5000A		MTACD3-1205000	1	1	18.301,38 \$
	6300A	MTACD3-1206300	1	1	25.574,26 \$	
4P	1000A	65 kA	MTACD4-0651000	1	1	6.011,83 \$
	1250A		MTACD4-0651250	1	1	5.806,42 \$
	1600A		MTACD4-0651600	1	1	5.806,42 \$
	2000A		MTACD4-0652000	1	1	6.949,90 \$
	2500A		MTACD4-0652500	1	1	9.770,94 \$
	3200A		MTACD4-0653200	1	1	10.380,34 \$
	4000A	120 kA	MTACD4-1204000	1	1	13.504,07 \$
	5000A		MTACD4-1205000	1	1	24.759,45 \$
	6300A	MTACD4-1206300	1	1	26.793,06 \$	

AC KONTAKTÖRLER - 230V AC

Kutup Sayısı	In (A) Anma Akımı	kW	Kontakt	Voltaj (V)	Ürün Kodu	Kutu Adedi	Koli Adedi	Fiyat (\$)
3P	9A	4kW	1NO	230V AC	MTMA10-3009	1	60	14,86 \$
	9A	4kW	1NC		MTMA01-3009	1	60	14,86 \$
	12A	5,5kW	1NO		MTMA10-3012	1	60	15,57 \$
	12A	5,5kW	1NC		MTMA01-3012	1	60	15,57 \$
	18A	7,5kW	1NO		MTMA10-3018	1	60	17,96 \$
	18A	7,5kW	1NC		MTMA01-3018	1	60	17,96 \$
	25A	11kW	1NO		MTMA10-3025	1	40	24,15 \$
	25A	11kW	1NC		MTMA01-3025	1	40	24,15 \$
	32A	15kW	1NO		MTMA10-3032	1	40	37,06 \$
	32A	15kW	1NC		MTMA01-3032	1	40	37,06 \$
	40A	18,5kW	1NO		MTMA10-3040	1	40	60,23 \$
	40A	18,5kW	1NC		MTMA01-3040	1	40	60,23 \$
	50A	22kW	1NO+1NC		MTMA11-3050	1	16	72,26 \$
	65A	30kW	1NO+1NC		MTMA11-3065	1	16	89,33 \$
	80A	37kW	1NO+1NC		MTMA11-3080	1	12	122,94 \$
	95A	45kW	1NO+1NC		MTMA11-3095	1	12	127,37 \$

MTMA SERİSİ



AC KONTAKTÖR YARDIMCI BLOKLARI

Ürün Kodu	Ürün Adı	Kutu Adedi	Koli Adedi	Fiyat (\$)
MTMAUX-UPBLOCKA	AC-3 KONTAKTÖR ÜST BLOK A			4,04 \$
MTMAUX-UPBLOCKB	AC-3 KONTAKTÖR ÜST BLOK B			6,64 \$
MTMAUX-SIDEBLOCK	AC-3 KONTAKTÖR YAN BLOK			8,72 \$

MINİ KONTAKTÖRLER

Kutup Sayısı	In (A) Anma Akımı	kW	Kontakt	Voltaj (V)	Ürün Kodu	Kutu Adedi	Koli Adedi	Fiyat (\$)
3P	9A	4kW	1NO	230V AC	MTMK10-3009	1	100	14,46 \$
	12A	5,5kW	1NO		MTMK10-3012	1	100	15,26 \$
	16A	7,5kW	1NO		MTMK10-3016	1	100	23,03 \$
	9A	4kW	1NC	230V AC	MTMK01-3009	1	100	14,46 \$
	12A	5,5kW	1NC		MTMK01-3012	1	100	15,26 \$
	16A	7,5kW	1NC		MTMK01-3016	1	100	23,03 \$
	9A	4kW	1NO	24V DC	MTMK10-3009DC24	1	100	24,19 \$
	12A	5,5kW	1NO		MTMK10-3012DC24	1	100	26,07 \$
	16A	7,5kW	1NO		MTMK10-3016DC24	1	100	27,85 \$
	9A	4kW	1NC	24V DC	MTMK01-3009DC24	1	100	24,19 \$
	12A	5,5kW	1NC		MTMK01-3012DC24	1	100	26,07 \$
	16A	7,5kW	1NC		MTMK01-3016DC24	1	100	27,85 \$

MTMK SERİSİ



AC KOMPANZASYON BLOKLARI

Kutup Sayısı	In (A) Anma Akımı	kVAr	Kontakt	Ürün Kodu	Kutu Adedi	Koli Adedi	Fiyat (\$)
3P	18A	7,5kVAr	1NO+1NC	MTMAC1-318	1	32	54,17 \$
	25A	12kVAr	1NO+1NC	MTMAC1-325	1	32	70,88 \$
	32A	18kVAr	1NO+1NC	MTMAC1-332	1	32	100,84 \$
	43A	20kVAr	1NO+1NC	MTMAC1-343	1	16	172,41 \$
	50A	25kVAr	2NO +1NC	MTMAC1-350	1	16	178,06 \$
	65A	30kVAr	2NO +1NC	MTMAC1-365	1	16	258,62 \$
	80A	40kVAr	2NO +1NC	MTMAC1-380	1	16	273,13 \$
	95A	50kVAr	2NO +1NC	MTMAC1-395	1	16	281,78 \$

MTMAC SERİSİ

MODÜLER KONTAKTÖRLER

MTMCO SERİSİ



Kutup Sayısı	In (A) Anma Akımı	Kontakt	mm	Ürün Kodu	Kutu Adedi	Koli Adedi	Fiyat (\$)	
2P	16A	1NO+1NC	18 mm	MTMCO-201611	1	140	17,48 \$	
	16A	2NO		MTMCO-201620	1	140	17,48 \$	
	16A	2NC		MTMCO-201602	1	140	17,48 \$	
	25A	1NO+1NC		MTMCO-202511	1	140	19,21 \$	
	25A	2NO		MTMCO-202520	1	140	19,21 \$	
	25A	2NC		MTMCO-202502		140	19,21 \$	
	32A	1NO+1NC	36 mm	MTMCO-203211	1	70	41,86 \$	
	32A	2NO		MTMCO-203220	1	70	41,86 \$	
	32A	2NC		MTMCO-203202	1	70	41,86 \$	
	40A	1NO+1NC		MTMCO-204011	1	70	46,55 \$	
	40A	2NO		MTMCO-204020	1	70	46,55 \$	
	40A	2NC		MTMCO-204002	1	70	46,55 \$	
	63A	1NO+1NC	54 mm	MTMCO-206311	1	70	57,76 \$	
	63A	2NO		MTMCO-206320	1	70	57,76 \$	
	63A	2NC		MTMCO-206302	1	70	57,76 \$	
	80A	1NO+1NC		MTMCO-208011	1	50	110,86 \$	
	80A	2NO		MTMCO-208020	1	50	110,86 \$	
	80A	2NC		MTMCO-208002	1	50	110,86 \$	
4P	100A	1NO+1NC	54 mm	MTMCO-2010011	1	50	110,86 \$	
	100A	2NO		MTMCO-2010020	1	50	110,86 \$	
	100A	2NC		MTMCO-2010002	1	50	110,86 \$	
	16A	2NO+2NC		36 mm	MTMCO-401622	1	70	24,14 \$
	16A	3NO+1NC			MTMCO-401631	1	70	24,14 \$
	16A	1NO+3NC			MTMCO-401613	1	70	24,14 \$
	16A	4NO	MTMCO-401640		1	70	24,14 \$	
	16A	4NC	MTMCO-401604		1	70	24,14 \$	
	25A	2NO+2NC	MTMCO-402522		1	70	31,03 \$	
	25A	3NO+1NC	MTMCO-402531		1	70	31,03 \$	
	25A	1NO+3NC	MTMCO-402513		1	70	31,03 \$	
	25A	4NO	MTMCO-402540		1	70	31,03 \$	
	25A	4NC	MTMCO-402504		1	70	31,03 \$	
	32A	2NO+2NC	54 mm		MTMCO-403222	1	50	54,48 \$
	32A	3NO+1NC			MTMCO-403231	1	50	54,48 \$
	32A	1NO+3NC		MTMCO-403213	1	50	54,48 \$	
	32A	4NO		MTMCO-403240	1	50	54,48 \$	
	32A	4NC		MTMCO-403204	1	50	54,48 \$	
	40A	2NO+2NC		MTMCO-404022	1	50	51,72 \$	
	40A	3NO+1NC		MTMCO-404031	1	50	51,72 \$	
	40A	1NO+3NC		MTMCO-404013	1	50	51,72 \$	
	40A	4NO		MTMCO-404040	1	50	51,72 \$	
	40A	4NC		MTMCO-404004	1	50	51,72 \$	
	63A	2NO+2NC		MTMCO-406322	1	50	52,21 \$	
	63A	3NO+1NC		MTMCO-406331	1	50	52,21 \$	
	63A	1NO+3NC	MTMCO-406313	1	50	52,21 \$		
	63A	4NO	MTMCO-406340	1	50	51,72 \$		
	63A	4NC	MTMCO-406304	1	50	52,21 \$		
	4P	80A	2NO+2NC	108 mm	MTMCO-408022	1	30	179,65 \$
		80A	3NO+1NC		MTMCO-408031	1	30	179,65 \$
80A		1NO+3NC	MTMCO-408013		1	30	179,65 \$	
80A		4NO	MTMCO-408080		1	30	179,65 \$	
80A		4NC	MTMCO-408004		1	30	179,65 \$	
100A		2NO+2NC	MTMCO-410022		1	30	179,65 \$	
100A		3NO+1NC	MTMCO-410031		1	30	179,65 \$	
100A		1NO+3NC	MTMCO-410013		1	30	179,65 \$	
100A		4NO	MTMCO-410040		1	30	179,65 \$	
100A		4NC	MTMCO-410004		1	30	179,65 \$	

TERMİK RÖLELER

Termik Ayar Sahası (A)	Ürün Kodu	Kutu Adedi	Koli Adedi	Fiyat (\$)
0,1 ~ 0,16A	MTTR1-M1301	1	100	15,32 \$
0,16 ~ 0,25A	MTTR1-M1302	1	100	15,32 \$
0,25 ~ 0,40A	MTTR1-M1303	1	100	15,32 \$
0,40 ~ 0,63A	MTTR1-M1304	1	100	15,32 \$
0,63 ~ 1A	MTTR1-M1305	1	100	15,32 \$
1 ~ 1,6A	MTTR1-M1306	1	100	15,32 \$
1,6 ~ 2,5A	MTTR1-M1307	1	100	15,32 \$
2,5 ~ 4A	MTTR1-M1308	1	100	15,32 \$
4 ~ 6A	MTTR1-M1310	1	100	15,32 \$
5,5 ~ 8A	MTTR1-M1312	1	100	15,32 \$
7 ~ 10A	MTTR1-M1314	1	100	15,32 \$
9 ~ 13A	MTTR1-M1316	1	100	15,32 \$
12 ~ 18A	MTTR1-M1321	1	100	15,32 \$
17 ~ 25A	MTTR1-M1322	1	100	15,32 \$
23 ~ 32A	MTTR2-M2353	1	75	25,23 \$
30 ~ 40A	MTTR2-M2355	1	75	26,38 \$
17 ~ 25A BÜYÜK	MTTR3-M3322	1	50	26,90 \$
23 ~ 32A BÜYÜK	MTTR3-M3353	1	50	26,49 \$
30 ~ 40A BÜYÜK	MTTR3-M3355	1	50	26,49 \$
37 ~ 50A	MTTR3-M3357	1	50	26,96 \$
48 ~ 65A	MTTR3-M3359	1	50	27,28 \$
55 ~ 70A	MTTR3-M3361	1	50	27,86 \$
63 ~ 80A	MTTR3-M3363	1	50	30,48 \$
80 ~ 93A	MTTR3-M3365	1	50	31,63 \$

MTTR SERİSİ



MOTOR KORUMA ŞALTERLERİ

Termik Ayar Sahası (A)	Ürün Kodu	Kutu Adedi	Koli Adedi	Fiyat (\$)
0,1 - 0,16A	MTPSO-250016	1	50	30,15 \$
0,16 - 0,25A	MTPSO-250025	1	50	30,15 \$
0,25 - 0,40A	MTPSO-250040	1	50	30,15 \$
0,40 - 0,63A	MTPSO-250063	1	50	31,87 \$
0,63A	MTPSO-250100	1	50	31,87 \$
1 - 1,6A	MTPSO-250160	1	50	31,87 \$
1,6 - 2,5A	MTPSO-250250	1	50	31,87 \$
2,5 - 4A	MTPSO-250400	1	50	31,87 \$
4 - 6,3A	MTPSO-250630	1	50	33,18 \$
6 - 10A	MTPSO-251000	1	50	33,18 \$
9 - 14A	MTPSO-251400	1	50	33,59 \$
13 - 18A	MTPSO-251800	1	50	34,41 \$
17 - 23A	MTPSO-252300	1	50	35,31 \$
20 - 25A	MTPSO-252500	1	50	35,31 \$
24 - 32A	MTPSO-253200	1	50	52,27 \$
25 - 40A	MTPS1-804000	1	50	99,14 \$
36 - 50A	MTPS1-805000	1	50	105,69 \$
40 - 63A	MTPS1-806300	1	50	105,69 \$
56 - 80A	MTPS1-808000	1	50	146,66 \$

MTPSO SERİSİ



MOTOR KORUMA ŞALTERİ AKSESUARLARI

Ürün Kodu	Ürün Adı	Kutu Adedi	Koli Adedi	Fiyat (\$)
MTPSO-F11	1NO+1NC Yardımcı Kontak - Önden Monteli	10	500	21,88 \$
MTPSO-F20	2NO Yardımcı Kontak - Önden Monteli	10	500	21,88 \$
MTPSO-L11	1NO+1NC Yardımcı Kontak - Yandan Monteli	10	500	15,63 \$
MTPSO-L20	2NO Yardımcı Kontak - Yandan Monteli	10	500	15,63 \$
MTPS1-L11	1NO+1NC Yardımcı Kontak - Yandan Monteli	10	500	20,19 \$
MTPS1-L20	2NO Yardımcı Kontak - Yandan Monteli	10	500	18,79 \$
MTPSO-AB	230V Şant Açırma Bobini	1	100	15,80 \$
MTPSO-DG	400V Düşük Gerilim Açırma Bobini	1	100	66,69 \$
MTPSO-IP55K	IP55 Kutu - Motor Koruma Şalteri	1	50	18,05 \$



İngiliz Sistem Anahtar Prizler

 **Mutlusan**[®]
electric *41.yıl*

*Ürünlerle ilgili Detaylı Bilgi İçin Yetkili Bölge Temsilcinize Danışabilirsiniz.

MODÜLLER



Kod	Ürün Tanımı	Kutu Adedi	Koli Adedi	BeyazKrem Fiyat (₺)	Renkli Fiyat (₺)
2400 441 02XX	Dimmer 100 - 500w (1M) Rc	20	120	1.149,86	1.197,77
2400 541 02XX	Dimmer 100 - 500w (1M) CE	20	120	773,29	805,51



Kod	Ürün Tanımı	Kutu Adedi	Koli Adedi	BeyazKrem Fiyat (₺)	Renkli Fiyat (₺)
2400 442 02XX	Dimmer 100 - 500w (2M) Rc	10	60	1.219,38	1.270,19
2400 542 02XX	Dimmer 100 - 500w (2M) CE	10	60	987,65	1.028,80



Kod	Ürün Tanımı	Kutu Adedi	Koli Adedi	BeyazKrem Fiyat (₺)	Renkli Fiyat (₺)
2400 171 02XX	Tv Prizi (Sonlu) (1M)	20	120	543,14	556,35
2400 170 02XX	Tv Prizi (Geçişli) (1M)	20	120	543,14	556,35



Kod	Ürün Tanımı	Kutu Adedi	Koli Adedi	BeyazKrem Fiyat (₺)	Renkli Fiyat (₺)
2400 172 02XX	Tv Prizi F Dişi (1M)	20	120	227,88	251,15



Kod	Ürün Tanımı	Kutu Adedi	Koli Adedi	BeyazKrem Fiyat (₺)	Renkli Fiyat (₺)
2400 125 02XX	Telefon Prizi (Cat3) (1M)	20	120	214,42	225,90
2400 140 02XX	Data Prizi (Cat6) (1M)	20	120	255,13	276,35



Kod	Ürün Tanımı	Kutu Adedi	Koli Adedi	BeyazKrem Fiyat (₺)	Renkli Fiyat (₺)
2400 482 02XX	RCA Çıkışı 2'li (1M)	20	120	197,82	520,38



Kod	Ürün Tanımı	Kutu Adedi	Koli Adedi	BeyazKrem Fiyat (₺)	Renkli Fiyat (₺)
2400 121 02XX	Kör Kapak (1M)	20	120	19,87	42,18



Kod	Ürün Tanımı	Kutu Adedi	Koli Adedi	Fiyat (₺)
2400 000 0001	Mavi Lamba	50	-	66,67



SPEAKHONE

RCA

3,5 SES JAKI

XLR ERKEK

XLR DIŞI

USB PRINTER

RİTA MODÜLER SİSTEM

Kod	Ürün Tanımı	Kutu Adedi	Fiyat
2200 250 01XX	Mek+Tuş Speakhone Prizi	1	MÜŞTERİ TEMSİLCİSİNE FİYAT SORUNUZ
2200 251 01XX	Mek+Tuş RCA Prizi	1	
2200 252 01XX	Mek+Tuş 3,5 Ses Jaki	1	
2200 253 01XX	Mek+Tuş XLR Erkek Prizi	1	
2200 254 01XX	Mek+Tuş XLR Dişi Prizi	1	
2200 255 01XX	Mek+Tuş Usb Printer Prizi	1	

ENERGY SAVER ÜRÜN LİSTESİ

Kod	Ürün Tanımı	Kutu Adedi	Fiyat
2110 052 0001	Energy Saver Kapak	1	MÜŞTERİ TEMSİLCİSİNE FİYAT SORUNUZ
2100 012 01XX	Mek+Tuş Impuls Anahtar	12	
2100 023 01XX	Mek+Tuş Impuls Komütatör	12	
2100 024 01XX	Mek+Tuş Impuls Işıklı Anahtar (220V)	12	
2100 027 01XX	Mek+Tuş Impuls Işıklı Komütatör	12	
2125 010 0101	Otel Uyarı İç Ünitesi Komütatörü (Mekanik) Işıklı	12	
2220 010 0101	Rita Otel Uyarı İç Ünitesi Komütatörü (Mekanik) Işıklı	12	
2220 010 0201	Rita Otel Uyarı İç Ünitesi Komütatörü (Mekanik) Işıklı Vidalı	12	
2200 412 01XX	Rita Mek Tuş Impuls Anahtar (Klipsli)	12	
2200 412 02XX	Rita Mek Tuş Impuls Anahtar (Vidalı)	12	
2200 423 01XX	Rita Mek Tuş Impuls Komütatör (Klipsli)	12	
2200 423 02XX	Rita Mek Tuş Impuls Komütatör (Vidalı)	12	
2200 424 01XX	Rita Mek Tuş Impuls Işıklı Anahtar(Klipsli)	12	
2200 424 02XX	Rita Mek Tuş Impuls Işıklı Anahtar (Vidalı)	12	
2200 427 01XX	Rita Mek Tuş Impuls Işıklı Komütatör (Klipsli)	12	
2200 427 02XX	Rita Mek Tuş Impuls Işıklı Komütatör (Vidalı)	12	

KABLOLARINIZ EMİN ELLEERDE



YENİ



ELEKTRİK İZOLASYON BANDI

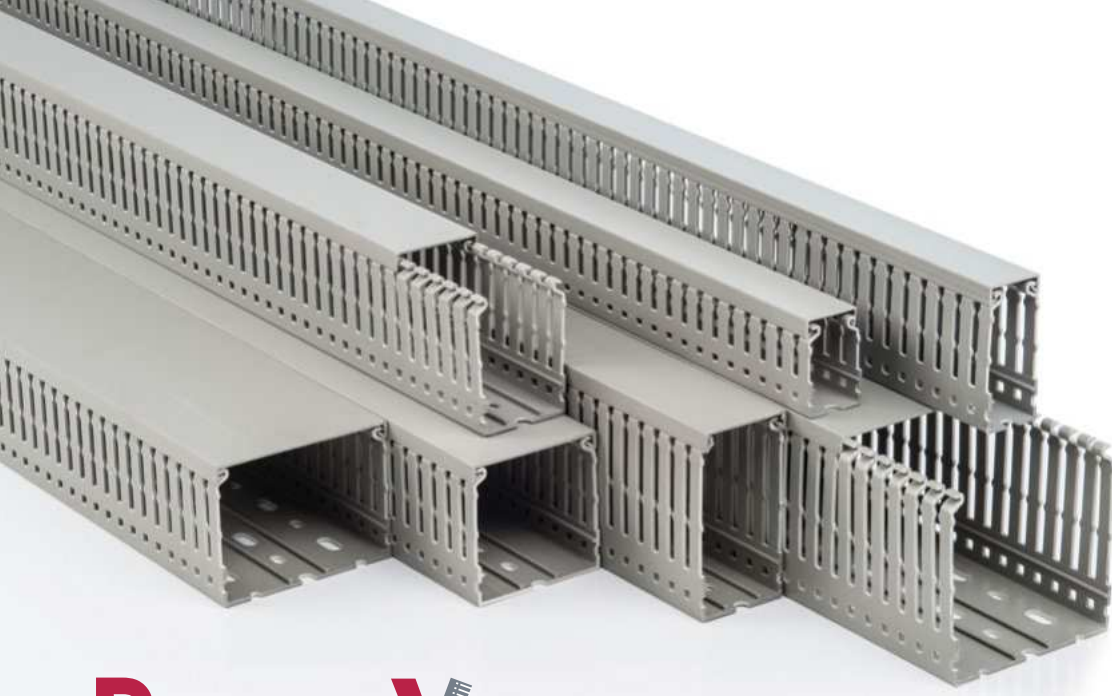

Promex

PANO TİPİ DELİKLİ KABLO KANALLARI



Ürün Kodu	Ölçü (mm)	Ürün Adı	Slot Aralığı (mm)	Ambalaj/Mt.	Fiyat (₺)
PROMEX DELİKLİ KABLO KANALI					
001 105 025030 20 17	25x30	PROMEX DELİKLİ KABLO KANALI	4/6/4 mm	2m. 120	86,30
001 105 025040 20 17	25x40	PROMEX DELİKLİ KABLO KANALI	4/6/4 mm	2m. 128	92,30
001 105 025060 20 17	25x60	PROMEX DELİKLİ KABLO KANALI	4/6/4 mm	2m. 96	121,80
001 105 025080 20 17	25x80	PROMEX DELİKLİ KABLO KANALI	4/6/4 mm	2m. 64	156,10
001 105 040040 20 17	40x40	PROMEX DELİKLİ KABLO KANALI	4/6/4 mm	2m. 70	119,80
001 105 040060 20 17	40x60	PROMEX DELİKLİ KABLO KANALI	4/6/4 mm	2m. 60	141,00
001 105 040080 20 17	40x80	PROMEX DELİKLİ KABLO KANALI	4/6/4 mm	2m. 40	187,20
001 105 040100 20 17	40x100	PROMEX DELİKLİ KABLO KANALI	5/8/5 mm	2m. 40	227,60
001 105 060040 20 17	60x40	PROMEX DELİKLİ KABLO KANALI	4/6/4 mm	2m. 50	164,50
001 105 060060 20 17	60x60	PROMEX DELİKLİ KABLO KANALI	4/6/4 mm	2m. 48	196,70
001 105 060080 20 17	60x80	PROMEX DELİKLİ KABLO KANALI	4/6/4 mm	2m. 32	243,60
001 105 060100 20 17	60x100	PROMEX DELİKLİ KABLO KANALI	5/8/5 mm	2m. 32	262,50
001 105 080060 20 17	80x60	PROMEX DELİKLİ KABLO KANALI	4/6/4 mm	2m. 25	234,40
001 105 080080 20 17	80x80	PROMEX DELİKLİ KABLO KANALI	4/6/4 mm	2m. 24	291,40
001 105 080100 20 17	80x100	PROMEX DELİKLİ KABLO KANALI	5/8/5 mm	2m. 24	433,00
001 105 100060 20 17	100x60	PROMEX DELİKLİ KABLO KANALI	4/6/4 mm	2m. 20	321,80
001 105 100080 20 17	100x80	PROMEX DELİKLİ KABLO KANALI	4/6/4 mm	2m. 20	326,80
001 105 100100 20 17	100x100	PROMEX DELİKLİ KABLO KANALI	5/8/5 mm	2m. 16	508,20
001 105 120060 20 17	120x60	PROMEX DELİKLİ KABLO KANALI	4/6/4 mm	2m. 20	332,20
001 105 120080 20 17	120x80	PROMEX DELİKLİ KABLO KANALI	4/6/4 mm	2m. 16	438,30

PROMEX KABLO KANALI KAPAKLARI

001 016 100025 20 17	25'LİK	PROMEX KAPAK		50	24,80
001 016 100040 20 17	40'LİK	PROMEX KAPAK		50	30,90
001 016 100060 20 17	60'LİK	PROMEX KAPAK		50	47,60
001 016 100080 20 17	80'LİK	PROMEX KAPAK		50	59,20
001 016 100100 20 17	100'LÜK	PROMEX KAPAK		50	68,90
001 016 100120 20 17	120'LİK	PROMEX KAPAK		50	85,60

Promex^{PANO}



PROMEX OPAK KAPAKLI ABS PANOLAR

Ürün Kodu	Ölçü (mm)	Ürün Adı	Ağırlık (kg)	Adet	Fiyat (₺)
001 046 203013 00 17	20x30x13	PROMEX PLASTİK OPAK KAPAKLI PANO	1,70	1	827,10
001 046 253515 00 17	25x35x15	PROMEX PLASTİK OPAK KAPAKLI PANO	2,20	1	1.201,80
001 046 304017 00 17	30x40x17	PROMEX PLASTİK OPAK KAPAKLI PANO	3,00	1	1.488,00
001 046 304022 00 17	30x40x22	PROMEX PLASTİK OPAK KAPAKLI PANO	3,40	1	1.760,20
001 046 355019 00 17	35x50x19	PROMEX PLASTİK OPAK KAPAKLI PANO	4,30	1	2.162,50
001 046 405018 00 17	40x50x18	PROMEX PLASTİK OPAK KAPAKLI PANO	4,30	1	2.380,60
001 046 405024 00 17	40x50x24	PROMEX PLASTİK OPAK KAPAKLI PANO	5,60	1	2.686,60
001 046 406020 00 17	40x60x20	PROMEX PLASTİK OPAK KAPAKLI PANO	6,00	1	2.956,70
001 046 507025 00 17	50x70x25	PROMEX PLASTİK OPAK KAPAKLI PANO	10,10	1	4.477,80
001 046 608026 00 17	60x80x26	PROMEX PLASTİK OPAK KAPAKLI PANO	13,50	1	7.113,50

PROMEX ŞEFFAF KAPAKLI ABS PANOLAR

Ürün Kodu	Ölçü (mm)	Ürün Adı	Ağırlık (kg)	Adet	Fiyat (₺)
001 046 203013 00 44	20x30x13	PROMEX PLASTİK ŞEFFAF KAPAKLI PANO	1,70	1	872,60
001 046 253515 00 44	25x35x15	PROMEX PLASTİK ŞEFFAF KAPAKLI PANO	2,20	1	1.220,00
001 046 304017 00 44	30x40x17	PROMEX PLASTİK ŞEFFAF KAPAKLI PANO	3,00	1	1.498,40
001 046 304022 00 44	30x40x22	PROMEX PLASTİK ŞEFFAF KAPAKLI PANO	3,40	1	1.776,90
001 046 355019 00 44	35x50x19	PROMEX PLASTİK ŞEFFAF KAPAKLI PANO	4,30	1	2.183,50
001 046 405018 00 44	40x50x18	PROMEX PLASTİK ŞEFFAF KAPAKLI PANO	4,30	1	2.373,70
001 046 405024 00 44	40x50x24	PROMEX PLASTİK ŞEFFAF KAPAKLI PANO	5,60	1	2.821,20
001 046 406020 00 44	40x60x20	PROMEX PLASTİK ŞEFFAF KAPAKLI PANO	6,00	1	2.960,80
001 046 507025 00 44	50x70x25	PROMEX PLASTİK ŞEFFAF KAPAKLI PANO	10,10	1	4.481,60
001 046 608026 00 44	60x80x26	PROMEX PLASTİK ŞEFFAF KAPAKLI PANO	13,50	1	7.133,80



IP65 CE

PROMEX OPAK KAPAKLI ABS OTOMAT PANOLAR

Ürün Kodu	Ölçü (mm)	Ürün Adı	Ağırlık (kg)	Adet	Fiyat (₺)
001 046 253515 01 17	25x35x15	PROMEX 18 OTOMATLI (9x2)	2,50	1	2.241,00
001 046 304017 01 17	30x40x17	PROMEX 24 OTOMATLI (12x2)	3,40	1	2.672,80
001 046 355019 01 17	35x50x19	PROMEX 45 OTOMATLI (15x3)	4,50	1	3.417,30
001 046 406020 01 17	40x60x20	PROMEX 60 OTOMATLI (15x4)	6,00	1	4.084,80



IP65 CE

PROMEX ŞEFFAF KAPAKLI ABS OTOMAT PANOLAR

Ürün Kodu	Ölçü (mm)	Ürün Adı	Ağırlık (kg)	Adet	Fiyat (₺)
001 046 253515 01 44	25x35x15	PROMEX 18 OTOMATLI (9x2)	2,50	1	2.254,00
001 046 304017 01 44	30x40x17	PROMEX 24 OTOMATLI (12x2)	3,40	1	2.681,80
001 046 355019 01 44	35x50x19	PROMEX 45 OTOMATLI (15x3)	4,50	1	3.436,50
001 046 406020 01 44	40x60x20	PROMEX 60 OTOMATLI (15x4)	6,00	1	4.333,60

PROMEX SERİSİ TEPE FANLARI



IP54



Poliüretan Conta



Radyal Fan

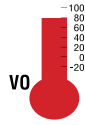

VO Alev İletmez ABS

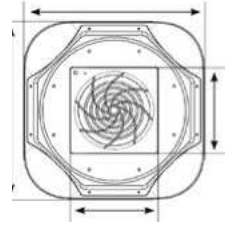

PROMEX TEPE FANLARI

Ürün Kodu	Fan Tipi	Besleme	Güç (W)	Nominal Akım	Gürültü Seviyesi	Kapasite	Adet	Fiyat
048 095 000100	Ø172x163x51 AKSİYEL	220V AC 50/60 Hz	25/32W	0,11/0,15A	57 dB	400 m³/h	1	132,80 \$
048 095 000101	Ø190x68 RADYAL	220V AC 50/60 Hz	58/75W	0,26/0,34A	62 dB	560 m³/h	1	199,30 \$
048 095 000102	Ø220X71 RADYAL	220V AC 50/60 Hz	85/90W	0,38/0,44A	73 dB	970 m³/h	1	232,70 \$



Vidasız hızlı ve kolay montaj !



IP54



Poliüretan Conta



Radyal Fan

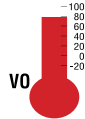

VO Alev İletmez ABS



Hızlı ve Kolay Montaj

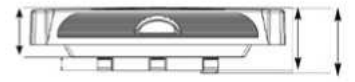
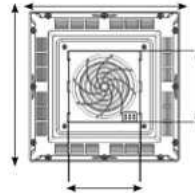

Ürün Kodu	Fan Tipi	Besleme	Güç (W)	Nominal Akım	Gürültü Seviyesi	Kapasite	Adet	Fiyat
048 095 000200	Ø172x163x51 AKSİYEL	220V AC 50/60 Hz	25/32W	0,11/0,15A	57 dB	400 m³/h	1	132,80 \$
048 095 000201	Ø190x68 RADYAL	220V AC 50/60 Hz	58/75W	0,26/0,34A	62 dB	560 m³/h	1	199,30 \$
048 095 000202	Ø220X71 RADYAL	220V AC 50/60 Hz	85/90W	0,38/0,44A	73 dB	970 m³/h	1	232,70 \$

FİLTRELİ FANLAR



048 095 000500



048 095 000501



048 095 000502

ÜRÜN KODU	048 095 000500	048 095 000501	048 095 000502
ÖLÇÜ (mm)	120x120x58,5	160x160x69	120x120x58,5
KESİM ÖLÇÜSÜ (mm)	92x92	125x125	92x92
FAN TİPİ	80x80x38	120x120x38	80x80x38
BESLEME (V AC)	230V-50/60Hz	230V-50/60Hz	230V-50/60Hz
GÜÇ (W)	14 (13)	26 (23)	14 (13)
HIZ (rpm)	2800	2700	2800
FİLTRELİ (m ³ /h)	30	100	30
FİLTRESİZ (m ³ /h)	41	140	41
NOMİNAL AKIM	0,08 / 0,07	0,14 / 0,13	0,8 / 0,7
GÜRÜLTÜ SEVİYESİ (db)	28 (31)	42 (46)	28 (31)
AD. / FİYAT	39,90 \$	46,80 \$	46,80 \$



048 095 000600



048 095 000601



048 095 000602



048 095 000603

ÜRÜN KODU	048 095 000600	048 095 000601	048 095 000602	048 095 000603
ÖLÇÜ (mm)	160x160x69	210x210x98	210x210x83	260x260x103
KESİM ÖLÇÜSÜ (mm)	125x125	177x177	177x177	223x223
FAN TİPİ	120x120x38	120x120x38	173x163x51	120x120x38
BESLEME (V AC)	230V-50/60Hz	230V-50/60Hz	230V-50/60Hz	230V-50/60Hz
GÜÇ (W)	26 (23)	26 (23)	37 (35)	26 (23)
HIZ (rpm)	2700	2700	2400	2700
FİLTRELİ (m ³ /h)	100	125	175	115
FİLTRESİZ (m ³ /h)	140	175	245	130
NOMİNAL AKIM	0,14 / 0,13	0,14 / 0,13	0,23 / 0,22	0,14 / 0,13
GÜRÜLTÜ SEVİYESİ (db)	42 (46)	42 (46)	52 (53)	42 (46)
AD. / FİYAT	53,10 \$	73,80 \$	93,00 \$	79,70 \$



048 095 000604



048 095 000605



048 095 000606



048 095 000607

ÜRÜN KODU	048 095 000604	048 095 000605	048 095 000606	048 095 000607
ÖLÇÜ (mm)	260x260x116	260x260x111	325x325x145	325x325x111
KESİM ÖLÇÜSÜ (mm)	223x223	223x223	291x291	291x291
FAN TİPİ	172x126x51	225x225x80	225x225x80	280x280x80
BESLEME (V AC)	230V-50/60Hz	230V-50/60Hz	230V-50/60Hz	230V-50/60Hz
GÜÇ (W)	37 (35)	66 (75)	66 (75)	110 (140)
HIZ (rpm)	2400	2600	2600	2600
FİLTRELİ (m ³ /h)	240	650	700	850
FİLTRESİZ (m ³ /h)	270	900	950	1200
NOMİNAL AKIM	0,23 / 0,22	0,35 / 0,38	0,35 / 0,38	0,50 / 0,72
GÜRÜLTÜ SEVİYESİ (db)	52 (53)	60 (63)	60 (63)	65 (68)
AD. / FİYAT	106,30 \$	265,70 \$	290,20 \$	299,10 \$



MINİ ISITICI



PTC ISITICI



SLİM ISITICI

PANO ISITICILARI

Ürün Kodu	Ürün Adı	Besleme	Koruma Sınıfı	Ölçüler (AxBxC)mm	Bağlantı	Adet	Fiyat (\$)
048 095 000700	15W PTC PANO ISITICISI	100-250V AC-DC	IP20	60x50x27	KABLO	1	43,50 \$
048 095 000701	25W PTC PANO ISITICISI	100-250V AC-DC	IP20	70x50x27	KABLO	1	51,20 \$
048 095 000702	30W PTC PANO ISITICISI	100-250V AC-DC	IP20	128x70x59	KLEMENS	1	64,00 \$
048 095 000703	50W PTC PANO ISITICISI	100-250V AC-DC	IP20	138x70x59	KLEMENS	1	76,70 \$
048 095 000704	75W PTC PANO ISITICISI	100-250V AC-DC	IP20	178x70x59	KLEMENS	1	121,50 \$
048 095 000705	100W PTC PANO ISITICISI	100-250V AC-DC	IP20	188x70x59	KLEMENS	1	129,80 \$
048 095 000706	150W PTC PANO ISITICISI	100-250V AC-DC	IP20	228x70x59	KLEMENS	1	147,10 \$
048 095 000707	30W SLIM PTC PANO ISITICISI	100-250V AC-DC	IP20	128x27x80	KLEMENS	1	60,70 \$
048 095 000708	50W SLIM PTC PANO ISITICISI	100-250V AC-DC	IP20	138x27x80	KLEMENS	1	69,10 \$
048 095 000709	75W SLIM PTC PANO ISITICISI	100-250V AC-DC	IP20	178x27x80	KLEMENS	1	112,50 \$
048 095 000710	100W SLIM PTC PANO ISITICISI	100-250V AC-DC	IP20	188x27x80	KLEMENS	1	120,90 \$
048 095 000711	150W SLIM PTC PANO ISITICISI	100-250V AC-DC	IP20	228x27x80	KLEMENS	1	138,10 \$



FANLI PTC ISITICI



FANLI ISITICI



400W PLASTİK FANLI ISITICI

FANLI PANO ISITICILARI

Ürün Kodu	Ürün Adı	Besleme	Koruma Sınıfı	Ölçüler (AxBxC)mm	Bağlantı	Adet	Fiyat (\$)
048 095 000800	100W FANLI PTC PANO ISITICISI	230V AC 50/60 Hz	IP20	170x89x60	KLEMENS	1	172,70 \$
048 095 000801	150W FANLI PTC PANO ISITICISI	230V AC 50/60 Hz	IP20	210x89x60	KLEMENS	1	241,70 \$
048 095 000802	250W FANLI REZİSTANS PANO ISITICISI	230V AC 50/60 Hz	IP20	152x110x80	KLEMENS	1	259,00 \$
048 095 000803	500W FANLI REZİSTANS PANO ISITICISI	230V AC 50/60 Hz	IP20	182x110x80	KLEMENS	1	294,20 \$
048 095 000804	750W FANLI REZİSTANS PANO ISITICISI	230V AC 50/60 Hz	IP20	232x110x80	KLEMENS	1	337,00 \$
048 095 000805	200/300/400W FANLI PTC PANO ISITICISI	230V AC 50/60 Hz	IP20	99x70x67	KABLO	1	301,80 \$

İZOLELİ KABLO YÜKSÜKLERİ - TEK GİRİŞ FRANSIZ - ALMAN NORMLARI



Standart : DIN 46228
Malzeme : Bakır
İzolasyon : Nylon
Voltaj : <600V
Çalışma Sıcaklığı : Max. 105°

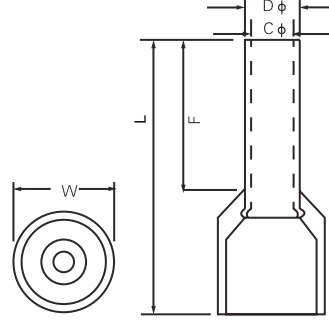

X= 0 Fransız X= F Fransız
X= 2 Alman X=A Alman

Ürün Kodu	Model Kodu	Ebatlar					Kablo Kesiti	Renk		Kutu Adet	Fiyat (Adet/₺)
		F	L	W	DØ	CØ		Fransız	Alman		
014 100 X10258	ITYX-0258	8.0	12.5	2.5	1.0	0.7	0.25	Menekşe	Mavi	1.000	0,97
014 100 X10348	ITYX-0348	8.0	12.5	2.5	1.1	0.8	0.34	Pembe	Turkuaz	1.000	0,97
014 100 X10508	ITYX-0508	8.0	14.0	2.6	1.3	1.0	0.50	Beyaz	Turuncu	1.000	0,43
014 100 X17508	ITYX-7508	8.0	14.6	2.8	1.6	1.3	0.75	Mavi	Beyaz	1.000	0,43
014 100 X11008	ITYX-1008	8.0	14.6	3.0	1.8	1.5	1.0	Kırmızı	Sarı	1.000	0,43
014 100 X11508	ITYX-1508	8.0	16.4	3.5	2.1	1.8	1.5	Siyah	Kırmızı	1.000	0,48
014 100 X12508	ITYX-2508	8.0	15.2	4.0	2.6	2.3	2.5	Gri	Mavi	500	0,61
014 100 X14009	ITYX-4009	9.0	16.5	4.4	3.2	2.8	4.0	Turuncu	Gri	500	1,03
014 100 X16012	ITYX-6012	12.0	20.0	6.3	3.9	3.5	6.0	Yeşil	Siyah	250	1,39
014 100 X11012	ITYX-1012	12.0	21.5	7.6	4.9	4.5	10.0	Kahverengi	Bej	100	1,77
014 100 X11612	ITYX-1612	12.0	22.2	8.8	6.2	5.8	16.0	Bej	Yeşil	100	2,46
014 100 X12516	ITYX-2516	16.0	29.0	11.2	7.9	7.5	25.0	Siyah	Kahverengi	50	4,12
014 100 X13516	ITYX-3516	16.0	30.0	12.7	8.7	8.3	35.0	Kırmızı	Bej	25	5,12
014 100 X15020	ITYX-5020	20.0	36.0	15.3	10.9	10.3	50.0	Mavi	Yeşil	25	9,70
014 100 017020	ITYF-7020	20.0	37.0	16.0	14.3	13.5	70.0	Sarı	-	25	17,97



İZOLELİ KABLO YÜKSÜKLERİ - ÇİFT GİRİŞ FRANSIZ - ALMAN NORMLARI

Standart : DIN 46228
Malzeme : Bakır
İzolasyon : Nylon
Voltaj : <600V
Çalışma Sıcaklığı : Max. 105°

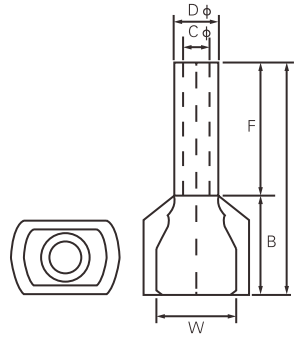

X= 0 Fransız X= F Fransız
X= 2 Alman X=A Alman

Ürün Kodu	Model Kodu	Ebatlar						Kablo Kesiti	Renk		Kutu Adet	Fiyat (Adet/₺)
		F	L	W	B	DØ	CØ		Fransız	Alman		
014 100 X20508	ICYX-0508	8.0	14.5	5.0	6.5	1.8	1.5	2x0.5	Beyaz	Turuncu	1.000	0,78
014 100 X27508	ICYX-7508	8.0	14.7	5.5	6.7	2.1	1.8	2x0.75	Mavi	Beyaz	500	0,82
014 100 X21008	ICYX-1008	8.0	15.1	5.5	7.1	2.3	2.0	2x1.0	Kırmızı	Sarı	500	0,88
014 100 X21508	ICYX-1508	8.0	15.5	6.4	7.2	2.6	2.3	2x1.5	Siyah	Kırmızı	500	1,06
014 100 X22510	ICYX-2510	10.0	18.5	8.0	8.5	3.3	2.9	2x2.5	Gri	Mavi	250	1,71
014 100 X24012	ICYX-4012	12.0	23.1	8.8	11.1	4.2	3.8	2x4.0	Turuncu	Gri	200	1,98
014 100 X26014	ICYX-6014	14.0	26.1	9.5	12.1	5.3	4.9	2x6.0	Yeşil	Siyah	100	2,46
014 100 X21014	ICYX-1014	14.0	26.6	12.6	12.0	6.9	6.5	2x10.0	Kahverengi	Bej	50	3,77
014 100 X21614	ICYX-1614	14.0	31.3	19.0	17.3	8.7	8.3	2x16.0	Bej	Yeşil	50	4,79

İZOLESİZ KABLO YÜKSÜKLERİ - TEK GİRİŞ



Standart : DIN 46228
Malzeme : Bakır
Voltaj : <600V
Çalışma Sıcaklığı : Max. 105°

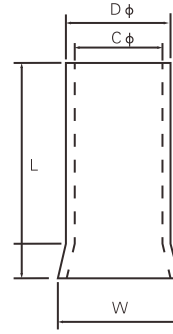

Ürün Kodu	Model Kodu	Ebatlar				Kablo Kesiti	Kutu Adet	Fiyat (Adet/₺)
		L	W	DØ	CØ			
014 100 120510	KTY-0508	10.0	1.7	1.3	1.0	0.50	2.000	0,45
014 100 127510	KTY-7508	10.0	1.9	1.6	1.3	0.75	1.000	0,47
014 100 121010	KTY-1008	10.0	2.2	1.8	1.5	1.0	1.000	0,47
014 100 121510	KTY-1508	10.0	2.5	2.1	1.8	1.5	1.000	0,52
014 100 122512	KTY-2508	12.0	3.3	2.6	2.3	2.5	1.000	0,70
014 100 124012	KTY-4009	12.0	3.9	3.2	2.8	4.0	1.000	0,95
014 100 126012	KTY-6012	12.0	4.8	3.9	3.5	6.0	500	1,30
014 100 121015	KTY-1012	15.0	5.8	4.9	4.5	10.0	250	2,16
014 100 121615	KTY-1612	15.0	7.2	6.2	5.8	16.0	250	2,72
014 100 122516	KTY-2516	16.0	9.1	7.9	7.5	25.0	100	4,14
014 100 123516	KTY-3516	16.0	10.2	8.7	8.3	35.0	100	4,70
014 100 125020	KTY-5020	20.0	12.4	10.9	10.3	50.0	50	9,77



İZOLELİ YUVARLAK TİP PAPUÇ

Standart : DIN 46228
Malzeme : Bakır
İzolasyon : PVC
Voltaj : <600V
Çalışma Sıcaklığı : Max. 105°

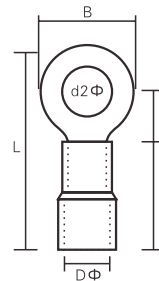

Ürün Kodu	Model Kodu	Civata Çapı (d2) mm	Ebatlar					Renk	Kablo Kesiti	Kutu Adet	Fiyat (Adet/₺)
			B	F	L	E	DØ				
014 100 030153	IYP-1,5-3	3.2	5.7	4.95	17.8	10.0	4.3	Kırmızı	0.5 ~1.5 mm ² 19A	200	1,41
014 100 030154	IYP-1,5-4	4.3	8.0	7.0	21.0	10.0	4.3			200	2,10
014 100 030155	IYP-1,5-5	5.3	9.5	8.5	22.2	10.0	4.3			200	2,13
014 100 030156	IYP-1,5-6	6.5	11.6	11.1	27.0	10.0	4.3			200	3,37
014 100 030158	IYP-1,5-8	8.5	11.6	11.1	27.0	10.0	4.3			200	3,37
014 100 030253	IYP-2,5-3	3.2	6.6	4.8	17.8	10.0	4.9	Mavi	1.5 ~2.5 mm ² 27A	200	2,61
014 100 030254	IYP-2,5-4	4.3	8.5	7.4	21.7	10.0	4.9			200	2,61
014 100 030255	IYP-2,5-5	5.3	9.5	7.4	22.5	10.0	4.9			200	2,64
014 100 030256	IYP-2,5-6	6.5	12.0	11.0	27.0	10.0	4.9			200	3,74
014 100 030258	IYP-2,5-8	8.5	12.0	11.0	27.0	10.0	4.9			200	3,74
014 100 032510	IYP-2,5-10	10.5	13.6	13.9	30.7	10.0	4.9	200	3,89		
014 100 036004	IYP-6-4	4.3	9.5	8.3	26.0	13.0	6.7	Sarı	4 ~6 mm ² 48A	100	5,54
014 100 036005	IYP-6-5	5.3	9.5	8.3	26.0	13.0	6.7			100	5,54
014 100 036006	IYP-6-6	6.5	12.0	10.5	29.5	13.0	6.7			100	6,29
014 100 036008	IYP-6-8	8.5	15.0	13.7	35.0	13.0	6.7			100	8,09
014 100 036010	IYP-6-10	10.5	15.0	13.7	35.0	13.0	6.7			100	8,16
014 100 036012	IYP-6-12	13.0	19.2	16.0	39.4	13.0	6.7			100	8,31

ÇATAL TİP İZOLELİ KABLO UÇLARI



Standart : DIN 46228
Malzeme : Bakır
İzolasyon : PVC
Voltaj : <600V
Çalışma Sıcaklığı : Max. 105°

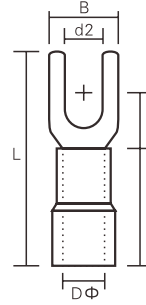

Ürün Kodu	Model Kodu	Civata Çapı (d2) mm	Ebatlar					Renk	Kablo Kesiti	Kutu Adet	Fiyat (Adet/₺)
			B	F	L	H	DØ				
014 100 040153	ICP-1,5-3	3.2	5.7	6.5	21.2	10.0	4.3	Kırmızı	0.5 ~1.5 mm ² 19A	200	1,92
014 100 040154	ICP-1,5-4	4.3	8.1	6.5	21.2	10.0	4.3			200	1,98
014 100 040155	ICP-1,5-5	5.3	9.5	6.5	21.2	10.0	4.3			200	2,07
014 100 040156	ICP-1,5-6	6.5	12.0	11.0	27.2	10.0	4.3			200	2,34
014 100 040253	ICP-2,5-3	3.2	5.7	6.5	21.2	10.0	4.9	Mavi	1.5 ~2.5 mm ² 27A	200	2,16
014 100 040254	ICP-2,5-4	4.3	8.1	6.5	21.2	10.0	4.9			200	2,22
014 100 040255	ICP-2,5-5	5.3	9.5	6.5	21.2	10.0	4.9			200	2,25
014 100 040256	ICP-2,5-6	6.5	12.0	11.0	27.2	10.0	4.9			200	2,99
014 100 046004	ICP-6-4	4.3	9.0	7.5	26.5	13.0	6.7	Sarı	4 ~6 mm ² 48A	100	4,87
014 100 046005	ICP-6-5	5.3	9.0	7.5	26.5	13.0	6.7			100	4,94
014 100 046006	ICP-6-6	6.5	12.0	12.0	32.5	13.0	6.7			100	6,59
014 100 046008	ICP-6-8	8.5	14.0	11.5	31.5	13.0	6.7			100	7,71

TAM İZOLELİ FASTON DİŞİ TERMİNAL



Malzeme : Pirinç
İzolasyon : PVC
Voltaj : <600V
Çalışma Sıcaklığı : Max. 75°

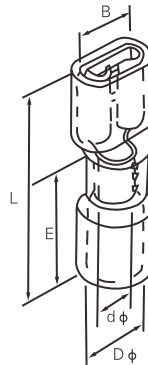

Ürün Kodu	Model Kodu	Soket Ölçüsü	Kalınlık (mm)	Ebatlar					Renk	Kablo Kesiti	Kutu Adet	Fiyat (Adet/₺)
				B	DØ	dØ	L	E				
014 100 090508	TDT-0,5-1/2.8	0.5x2.8	0.30	3.3	3.8	1.7	20.0	10.0	Kırmızı	0.5 ~1.5 mm ² 10A	200	2,16
014 100 090509	TDT-0,5-1/4.8	0.8x4.75	0.35	5.0	3.8	1.7	20.5	10.0			200	2,55
014 100 090510	TDT-0,5-1/6.4	0.8x6.35	0.40	6.6	3.8	1.7	22.4	10.0			200	3,03
014 100 091523	TDT-1,5-2,5/2.8	0.8x2.8	0.30	3.3	4.3	2.3	20.0	10.0	Mavi	1.5 ~2.5 mm ² 15A	200	2,55
014 100 091524	TDT-1,5-2,5/4.8	0.8x4.75	0.35	5.0	4.3	2.3	20.5	10.0			200	2,62
014 100 091525	TDT-1,5-2,5/6.4	0.8x6.35	0.40	6.6	4.3	2.3	22.7	10.0			200	3,18
014 100 094060	TDT-4-6	0.8x6.35	0.40	6.6	5.7	3.4	23.0	12.5	Sarı	4 ~6 mm ² 24A	100	3,66

TAM İZOLELİ DIŐI TERMİNAL



Malzeme : Pirinç
İzolasyon : PVC
Voltaj : <600V
Çalışma Sıcaklığı : Max.75°

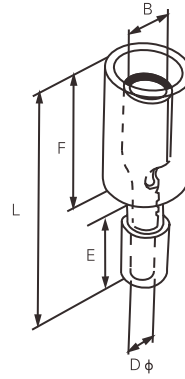

Ürün Kodu	Model Kodu	Kalınlık mm	Ebatlar					Renk	Kablo Kesiti	Kutu Adet	Fiyat (Adet/₺)
			B	F	DØ	E	L				
014 100 100510	YDT-0,5-1	0.40	4.0	7.0	1.7	10.5	23.3	Kırmızı	0.5 ~1.5 mm ² 10A	200	5,99
014 100 101525	YDT-1,5-2,5	0.40	5.0	7.0	2.3	10.5	25.1	Mavi	1.5 ~2.5 mm ² 15A	100	6,74
014 100 104060	YDT-4-6	0.40	5.0	7.0	3.4	12.5	25.1	Sarı	4 ~6 mm ² 24A	100	8,38

İZOLELİ EK MUF - UZUN TİP



Standart : DIN 46237
Malzeme : Bakır / Copper
İzolasyon : PVC
Voltaj : <600V
Çalışma Sıcaklığı : Max. 75°

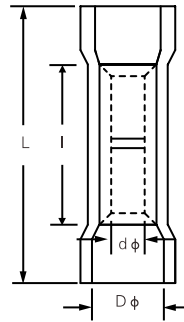

Ürün Kodu	Model Kodu	Maximum Akım	Ebatlar				Renk	Kablo Kesiti	Kutu Adet	Fiyat (Adet/₺)
			I	dØ	DØ	L				
014 100 070015	IEM-1,5	19A	15.0	1.7	4.3	25.0	Kırmızı	0.5 ~1.5 mm ²	200	2,99
014 100 070025	IEM-2,5	27A	15.0	2.3	4.9	25.0	Mavi	1.5 ~2.5 mm ²	200	2,99
014 100 070040	IEM-4	48A	15.0	3.4	6.7	25.0	Sarı	4 ~6 mm ²	100	5,09

İZOLELİ FASTON ERKEK TERMİNAL



Malzeme : Pirinç
İzolasyon : PVC
Voltaj : <600V
Çalışma Sıcaklığı : Max. 75°

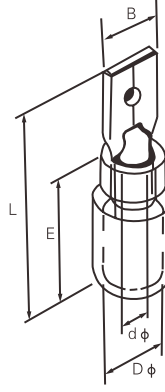

Ürün Kodu	Model Kodu	Soket Ölçüsü	Kalınlık (mm)	Ebatlar					Renk	Kablo Kesiti	Kutu Adet	Fiyat (Adet/₺)
				B	DØ	dØ	L	E				
014 100 060013	IFE-1,5/2.8	0.8x2.8	0.8	2.8	1.7	3.8	17.7	10.0	Kırmızı	0.5 ~1.5 mm ² 10A	200	1,42
014 100 060014	IFE-1,5/4.8	0.4x4.75	0.4x2	4.8	1.7	3.8	20.0	10.0			200	1,62
014 100 060015	IFE-1,5/6.4	0.8x6.35	0.4x2	6.4	1.7	3.8	21.0	10.0			200	2,10
014 100 060023	IFE-2,5/2.8	0.8x2.8	0.8	2.8	2.3	4.3	17.7	10.0	Mavi	1.5 ~2.5 mm ² 15A	200	1,42
014 100 060024	IFE-2,5/4.8	0.4x4.75	0.4x2	4.8	2.3	4.3	20.0	10.0			200	1,80
014 100 060025	IFE-2,5/6.4	0.8x6.35	0.4x2	6.4	2.3	4.3	21.0	10.0			200	2,20
014 100 060040	IFE-4	0.8x6.35	0.4x2	6.4	3.4	5.7	23.0	12.5	Sarı	4 ~6 mm ² 24A	200	2,58

YUVARLAK ERKEK TERMİNAL



Malzeme : Pirinç
İzolasyon : PVC
Voltaj : <600V
Çalışma Sıcaklığı : Max. 75°

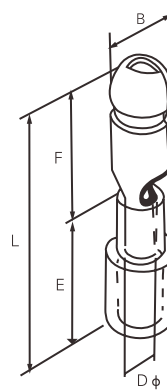

Ürün Kodu	Model Kodu	Kalınlık mm	Ebatlar					Renk	Kablo Kesiti	Kutu Adet	Fiyat (Adet/₺)
			B	F	DØ	E	L				
014 100 110510	YET-0,5-1	0.4	4.0	8.5	1.7	10.5	21.5	Kırmızı	0.5 ~1.5 mm ² 10A	200	4,94
014 100 111525	YET-1,5-2,5	0.4	5.0	8.5	2.3	10.5	21.7	Mavi	1.5 ~2.5 mm ² 15A	200	5,69
014 100 114060	YET-4-6	0.4	5.0	8.5	3.4	13.0	24.0	Sarı	4 ~6 mm ² 24A	200	7,64

İZOLELİ İĞNE TİP TERMİNAL



Malzeme : Bakır
İzolasyon : PVC
Voltaj : <600V
Çalışma Sıcaklığı : Max. 75°

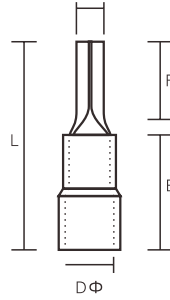

Ürün Kodu	Model Kodu	Kalınlık mm	Ebatlar					Renk	Kablo Kesiti	Kutu Adet	Fiyat (Adet/₺)
			B	F	L	E	DΦ				
014 100 050015	IIT-1,5	0.7	1.9	10.0	20.0	10.0	4.3	Kırmızı	0.5 ~1.5 mm ² 19A	200	2,25
014 100 050025	IIT-2,5	0.8	1.9	12.0	22.0	10.0	4.9	Mavi	1.5 ~2.5 mm ² 27A	200	2,70
014 100 050040	IIT-4	1.0	2.8	13.0	26.8	13.0	6.7	Sarı	4 ~6 mm ² 48A	100	6,44

İZOLELİ TAM DIŞI TERMİNAL



Malzeme : Bakır
İzolasyon : PVC
Voltaj : <600V
Çalışma Sıcaklığı : Max. 75°

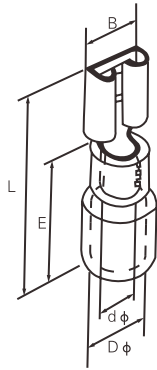

Ürün Kodu	Model Kodu	Soket Ölçüsü	Kalınlık (mm)	Ebatlar					Renk	Kablo Kesiti	Kutu Adet	Fiyat (Adet/₺)
				B	DΦ	dΦ	L	E				
014 100 080508	IDT-0,5-1/2.8	0.8x2.8	0.3	3.3	3.8	1.7	18.5	10.0	Kırmızı	0.5 ~1.5 mm ² 10A	200	1,33
014 100 080509	IDT-0,5-1/4.8	0.8x4.75	0.35	5.0	3.8	1.7	19.0	10.0			200	1,72
014 100 080510	IDT-0,5-1/6.4	0.8x6.35	0.4	6.6	3.8	1.7	19.8	10.0			200	2,22
014 100 081523	IDT-1,5-2,5/2.8	0.8x2.8	0.3	3.3	4.3	2.3	18.5	10.0	Mavi	1.5 ~2.5 mm ² 15A	200	1,72
014 100 081524	IDT-1,5-2,5/4.8	0.8x4.75	0.35	5.0	4.3	2.3	19.0	10.0			200	1,80
014 100 081525	IDT-1,5-2,5/6.4	0.8x6.35	0.4	6.6	4.3	2.3	19.0	10.0			200	2,27
014 100 084060	IDT-4-6	0.8x6.35	0.4	6.6	5.7	3.4	23.4	12.5	Sarı	4 ~6 mm ² 24A	100	2,59

İZOLELİ ERKEK - DIŞI TERMİNAL



Malzeme : Pirinç
İzolasyon : PVC
Voltaj : <600V
Çalışma Sıcaklığı : Max. 75°

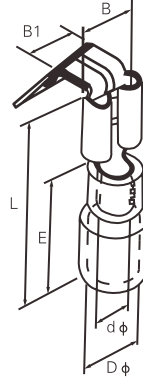

Ürün Kodu	Model Kodu	Soket Ölçüsü	Ebatlar						Renk	Kablo Kesiti	Kutu Adet	Fiyat (Adet/₺)
			B	B1	E	DØ	dØ	L				
014 100 130515	IEDT-0,5-1,5	0.8x6.35	6.6	6.35	10.0	3.8	1.7	22.5	Kırmızı	0.5 ~1.5 mm ² 10A	100	4,19
014 100 131525	IEDT-1,5-2,5	0.8x6.35	6.6	6.35	10.0	4.3	2.3	22.5	Mavi	1.5 ~2.5 mm ² 15A	100	4,34
014 100 134060	IEDT-4-6	0.8x6.35	6.6	6.35	13.0	5.7	3.4	24.0	Sarı	4 ~6 mm ² 24A	100	4,94

TAM İZOLELİ FASTON EĞİK DIŞI TERMİNAL



Malzeme : Pirinç
İzolasyon : Nylon
Voltaj : <600V
Sıcaklık : 105° 400V

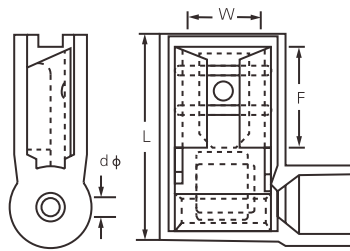

Ürün Kodu	Model Kodu	Soket Ölçüsü	Ebatlar				Renk	Kablo Kesiti	Kutu Adet	Fiyat (Adet/₺)
			W	F	L	dØ				
014 100 140515	TEDT-0,5-1,5	0.8x4.75	6.6	7.6	16.0	1.7	Kırmızı	0.5 ~1.5 mm ² 10A	100	5,54
014 100 141525	TEDT-1,5-2,5	0.8x6.35	6.6	7.6	16.0	2.3	Mavi	1.5 ~2.5 mm ² 15A	100	5,54
014 100 144060	TEDT-4-6	0.8x6.35	7.0	7.6	17.5	3.4	Sarı	4 ~6 mm ² 24A	100	18,82

SİNTAŞ SANAYİ TİPİ FİŞ - PRİZLER

Ürün Kodu	Ürün Adı	Kutu Adet	Koli Adet	Fiyat (₺)
019 107 016250	16X25 A.4 KUTUPLU FİŞ-PRİZ	1	30	983,90
019 107 016252	16X25 A.4 KUTUPLU PRİZ	1	45	516,50
019 107 016251	16X25 A.4 KUTUPLU FİŞ	1	60	467,30
019 107 025400	25x40 A.4 KUTUPLU FİŞ-PRİZ	1	15	1.279,10
019 107 025402	25x40 A.4 KUTUPLU PRİZ	1	25	664,10
019 107 025401	25x40 A.4 KUTUPLU FİŞ	1	35	614,90
019 107 040630	40X63 A.4 KUTUPLU FİŞ-PRİZ	1	10	1.648,00
019 107 040632	40X63 A.4 KUTUPLU PRİZ	1	15	860,90
019 107 040631	40X63 A.4 KUTUPLU FİŞ	1	25	787,10
019 107 063100	63X100 A.4 KUTUPLU FİŞ-PRİZ	1	5	2.656,50
019 107 063102	63X100 A.4 KUTUPLU PRİZ	1	10	1.377,40
019 107 063101	63X100 A.4 KUTUPLU FİŞ	1	15	1.279,10



SİNTAŞ SANAYİ TİPİ SEYYAR PRİZLER

Ürün Kodu	Ürün Adı	Kutu Adet	Koli Adet	Fiyat (₺)
019 107 016253	16X25 A.4 KUTUPLU SEYYAR PRİZ	1	45	516,50
019 107 025403	25x40 A.4 KUTUPLU SEYYAR PRİZ	1	25	664,10
019 107 040633	40X63 A.4 KUTUPLU SEYYAR PRİZ	1	15	860,90
019 107 063103	63X100 A.4 KUTUPLU SEYYAR PRİZ	1	10	1.377,40

ÇEVRE KOŞULLARINA
DAYANIKLI,
KABLOLAMA ve
MONTAJ KOLAYLIĞI



TERMOPLASTİK BUAT

EKO SERİSİ PROJE ÜRÜNLERİ



SPİRALLİ KABLolar

SPİRALLİ ENERJİ KABLolarI HALOJEN FREE



Ürün Kodu	Kablo Kesit (mm ²)	Spiral Özellik	Spiral Çap (Ø mm)
H07Z1-U (NYA) KABLolar HALOJEN FREE			
122 051 215014	2 x 1,5	HF-PE	16
122 051 315014	3 x 1,5	HF-PE	16
122 051 415016	4 x 1,5	HF-PE	16
122 051 515020	5 x 1,5	HF-PE	20
122 051 225014	2 x 2,5	HF-PE	16
122 051 325016	3 x 2,5	HF-PE	16
122 051 425020	4 x 2,5	HF-PE	16
122 051 525025	5 x 2,5	HF-PE	25

SPİRALLİ ZAYIF AKIM KABLolarI HALOJEN FREE



Ürün Kodu	Kablo Kesit (mm ²)	Spiral Özellik	Spiral Çap (Ø mm)
(LSZH) DATA KABLolarI HALOJEN FREE			
122 053 100516	U/UTP CAT5e (4x2x24AWG)	HF-PE	16
122 053 100616	U/UTP CAT6 (4x2x23AWG)	HF-PE	16
(PHY - HF) KOAKSİYEL KABLolarI HALOJEN FREE			
122 053 200416	RG 6 U/4 (Cu/AL)	HF-PE	16
122 053 200616	RG 6 U/6 (Cu/Cu)	HF-PE	16
CCTV KAMERA KABLolarI HALOJEN FREE			
122 053 301214	1+2 RG 59 Mini (2x0,50 mm ²)	HF-PE	16
122 053 301416	1+4 RG 59 Mini (2x0,50 mm ² + 2x0,22 mm ²)	HF-PE	16
J-H (st) H YANGIN İHBAR KABLolarI HALOJEN FREE			
122 053 401214	1x2x0,80 mm ² + 0,80 mm ²	HF-PE	16
122 053 402216	2x2x0,80 mm ² + 0,80 mm ²	HF-PE	16
LIHH DİYAFON KABLolarI HALOJEN FREE			
122 053 502216	LIHH 8x0,22 mm ²	HF-PE	16

Tüm spirallerin HALOJEN FREE özelliği mevcuttur.

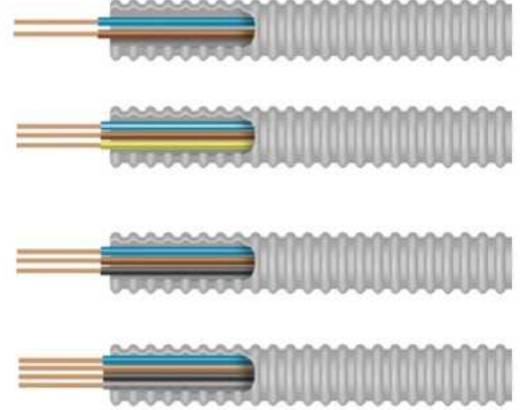

SPİRALLİ ENERJİ KABLolarI

Ürün Kodu	Kablo Kesit (mm ²)	Spiral Özellik	Spiral Çap (Ø mm)
H07Z1-U (NYA) KABLolar			
122 050 215014	2 x 1,5	HF-PE	16
122 050 315014	3 x 1,5	HF-PE	16
122 050 415016	4 x 1,5	HF-PE	16
122 050 515020	5 x 1,5	HF-PE	20
122 050 225014	2 x 2,5	HF-PE	16
122 050 325016	3 x 2,5	HF-PE	16
122 050 425020	4 x 2,5	HF-PE	16
122 050 525025	5 x 2,5	HF-PE	25

SPİRALLİ ZAYIF AKIM KABLolarI

Ürün Kodu	Kablo Kesit (mm ²)	Spiral Özellik	Spiral Çap (Ø mm)
DATA KABLolar			
122 052 100516	U/UTP CAT5e	HF-PE	16
122 052 100616	U/UTP CAT6e	HF-PE	16
KOAKSİYEL KABLolar			
122 052 200416	RG 59 U/2 (Cu/AL)	HF-PE	16
122 052 200616	RG 6 U/4 (Cu/AL)	HF-PE	16
122 052 200616	RG 6 U/6 (Cu/Cu)	HF-PE	16
CCTV KAMERA KABLolarI			
122 052 301214	CCTV 1+2 (2x0,22 mm ²)	HF-PE	16
122 052 301416	CCTV 1+4 (2x2x0,22 mm ²)	HF-PE	16
J-H (st) H YANGIN İHBAR KABLolarI			
122 052 401215	JY(st)Y 1x2x0,80 mm ² + 0,40 mm ²	HF-PE	16
122 052 402216	JY(st)Y 2x2x0,80 mm ² + 0,40 mm ²	HF-PE	16
LIHH DİYAFON KABLolarI			
122 052 502216	DT-8 8x0,22 mm ²	HF-PE	16

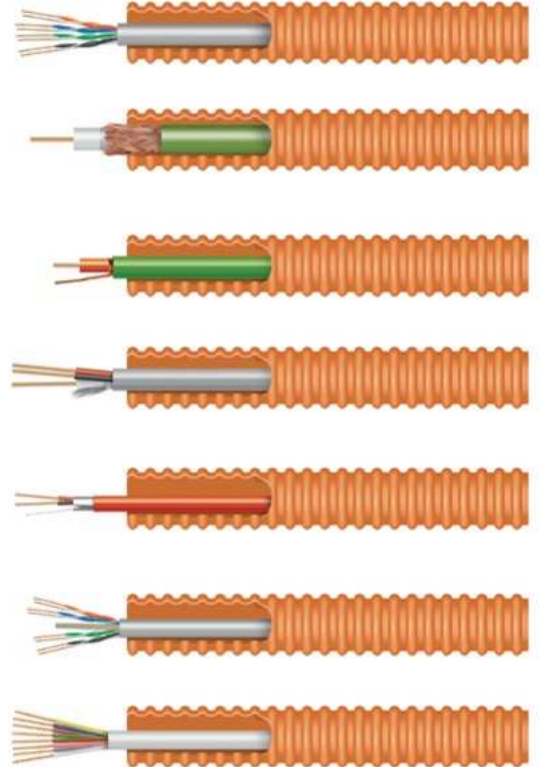

* Güncel fiyatlar için satış temsilciniz ile irtibata geçiniz.

**DAYANIKLI
GÜVENLİ
KOLAY
KULLANIM**



ŞALT GRUBU

Önceliğiniz
MUTLUSAN'ın
A.G. Çözümleri
OLACAK...



Detaylı Bilgi İçin





Mutlusan Plastik Elektrik San ve Tic. A.Ş.

İkitelli Org.San. Bölgesi Mahallesi Enkoop Cad.
No:7 Başakşehir- İstanbul
Tel : +90 (212) 485 05 44 (PBX)
Faks : +90 (212) 485 10 12

Karaköy Şube

Okçumusa Cad. Güneşhan İş Hanı No : 24/10
Karaköy-İstanbul
Tel : +90 (212) 237 06 02 (PBX)
Fax: +90 (212) 237 77 47

Perpa Şube

Perpa Tic. Merkezi. A Blok Kat: 2
No: 9-009 Okmeydanı - İstanbul
Tel : +90 (212) 320 05 78 (PBX)
Fax: +90 (212) 320 05 81